

## Product Features

- RF frequency: 11 to 65 GHz
- Insertion Loss: 2.7 dB
- Amplitude Balance: 0.5 dB
- Phase Balance: 1.5 deg
- DC Coupled
- High Power Handling
- Die Size: X=1250 um, Y=850 um, Z=100 um

## Application

- Instrumentation
- Wireless Communication
- SATCOM
- Radar, EW
- WLAN, WiMax

## Product Description

The TMC812D is a wideband low loss MMIC balun (balanced to unbalanced transformer) die with an impedance ratio of 1:2 . TMC812D is designed for use in 5G wireless, SATCOM, Instrumentation, high-speed track-and-hold amplifiers, digital-to-analog converters, balanced amplifiers, signal integrity and Military Radar and EW applications. The TMC812D is a 50  $\Omega$  matched, DC-coupled and ROHS-compliant design. The TMC812D is designed and fabricated for maximum repeatability with low insertion loss, low amplitude unbalance, low phase unbalance, and excellent common mode rejection to ensure rugged and reliable operation and moisture protection. Both bond pad and backside metallization are Au-based and compatible with ribbon and wedge bonding and high conductivity epoxy and eutectic die attach methods. TMC812D is layed out symmetrically and is in die format thus enabling the integration of the balun directly into hybrid modules.

<b>Electrical Performance</b>				
	<b>min</b>	<b>Typ</b>	<b>Max</b>	<b>Units</b>
<b>Frequency</b>	11		65	GHz
<b>Excess Insertion Loss</b>		2.7		dB
<b>Return Loss</b>		10		dB
<b>Common Mode Rejection</b>		35		dB
<b>Amplitude Balance</b>		0.5		dB
<b>Phase Match</b>		1.5		deg

# TMC812D

## 11-65 GHz

### Low Loss Balun

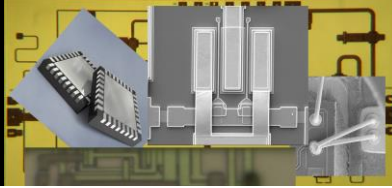

**mmTRON**  
Unleashing the  
mmWave Frontier

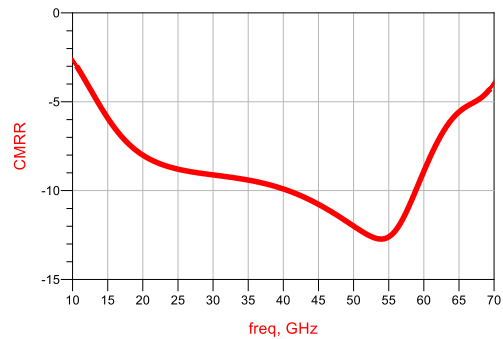
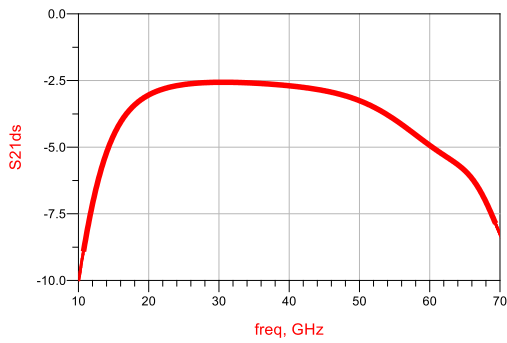
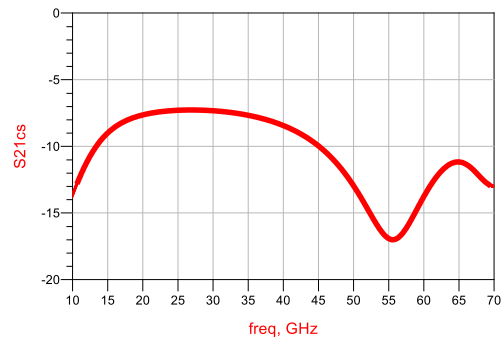
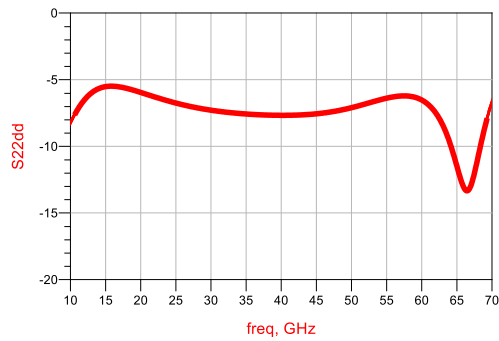

# TMC812D 11-65 GHz Low Loss Balun

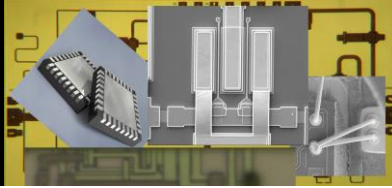

**mmTRON**  
Unleashing the  
mmWave Frontier

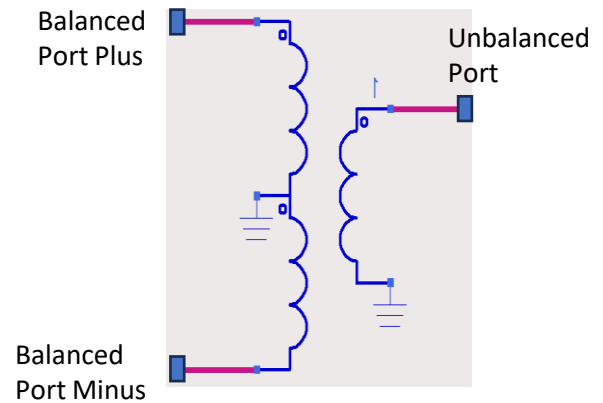
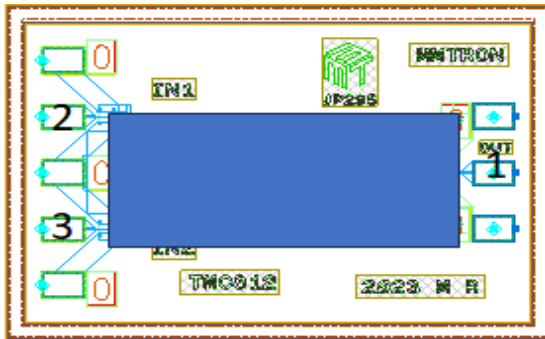

Pad #	Function
1	Unbalanced port
2	Balanced Port Plus
3	Balanced Port Minus

Pads 1, 2, and 3 are shorted to the ground.  
The remaining 5 pads are GND.

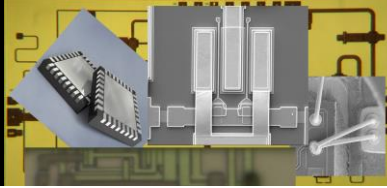

- **Assembly Techniques**

- The TMC812D is fabricated using a GaAs-based semiconductor material structure. The die is back-metalized and can be mounted with standard assembly techniques. The mounting surface should be clean and flat.

- **ESD Warning**

- III-V MMICs are ESD-sensitive. Preventative ESD measures must be employed in all aspects of storage, handling, and assembly. MMIC ESD precautions, handling considerations, and die-attach and bonding methods are critical factors in successful III-V MMIC performance and reliability.

- **RoHS Compliance**

- This part is RoHS compliant, meeting the requirements of the EU Restriction of Hazardous Substances Directive 2002/95/EC, commonly known as RoHS. Six substances are regulated: lead, mercury, cadmium, chromium VI (hexavalent chromium), polybrominated biphenyls (PBB), and polybrominated biphenyl ethers (PBDE). RoHS compliance requires that any residual concentration of these substances is below the Directive's maximum concentration values (MCV): cadmium 100ppm by weight and all others 1000ppm by weight.

- **Maximum Ratings**

Parameter	Function
Operating Temperature	-55 °C to 100 °C
Input RF Power	35 dBm at 25 °C

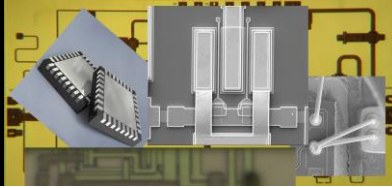

**mmTron Inc. (“mmTron”). All rights reserved.**

The information contained in this this datasheet is for reference only. All specifications are subject to change without prior notice.

Except as provided in its Terms and Conditions of Sale or any separate agreement, mmTron assumes no liability or responsibility whatsoever, including for (i) errors or omissions in these materials; (ii) failure to update these materials; or (iii) conflicts or incompatibilities arising from future changes to specifications and product descriptions, which mmTron may make at any time, without notice. These materials grant no license, express or implied, to any intellectual property rights. THESE MATERIALS ARE PROVIDED "AS IS" WITH NO WARRANTY OR LIABILITY, EXPRESS OR IMPLIED, RELATING TO SALE AND/OR USE OF mmTron PRODUCTS INCLUDING FITNESS FOR A PARTICULAR PURPOSE, MERCHANTABILITY, INFRINGEMENT OF INTELLECTUAL PROPERTY RIGHT, ACCURACY OR COMPLETENESS, OR SPECIAL, INDIRECT, INCIDENTAL, OR CONSEQUENTIAL DAMAGES WHICH MAY RESULT FROM USE OF THESE MATERIALS. mmTron products are not intended for use in medical, lifesaving or life sustaining applications. mmTron customers using or selling mmTron products for use in such applications do so at their own risk and agree to fully indemnify mmTron for any damages resulting from such improper use or sale. These items are controlled by the U.S. Government and authorized for export only to the country of ultimate destination for use by the ultimate consignee or end-user(s) herein identified. They may not be resold, transferred, or otherwise disposed of, to any other country or to any person other than the authorized ultimate consignee or end-user(s), either in their original form or after being incorporated into other items, without first obtaining approval from the U.S. government or as otherwise authorized by U.S. law and regulations’.

The product layout, and specification are mmTron Proprietary and confidential information. The recipient agrees not to copy, alter, modify, reverse engineer, or attempt to derive the composition or underlying information, structure or ideas of any Confidential Information and must not remove, overprint, deface or change any notice of confidentiality, copyright, trademark, logo, legend or other notices of ownership from any originals or copies of mmTron’s information.