

TMC215D

27-31 GHz

Linear Power Amplifier

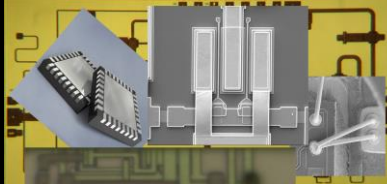

mmTRON
Unleashing the
mmWave Frontier

Product Features

- RF frequency: 27 to 31 GHz
- Linear Gain: 23 dB
- Psat: 46.5 dBm
- Die Size: X=5 mm, Y=4 mm, Z=0.1 mm
- DC Bias Point: 28 VDC, 3000 mA (VG1 = VG2 = VG3)

Application

- SSPA
- SATCOM uplink
- Military Radar, EW

Product Description

The TMC215D is a 27-31 GHz, linear power amplifier die product with high power-added efficiency. TMC215D is designed for use in SATCOM, Instrumentation, Military Radar, and EW applications. The TMC215D is a 50 Ω matched design with built-in DC blocking and ESD protection. To ensure rugged and reliable operation and moisture protection, the TMC215D is designed for maximum reliability. Both bond pad and backside metallization are Au-based that is compatible with ribbon and wedge bonding and high conductivity epoxy and eutectic die attach methods. TMC215D can be biased from 18V to 28V to adjust P1dB output power levels in the 25W to 45W range while maintaining excellent PAE and NPR. TMC215T is the bare die on a tab. Cu/CuMo/Cu, CuW and Ag-Diamond shims are available in both Silver epoxy and Eutectic Die attach. Please contact mmTron for the packaged version TMC215.

	Min	Typ	Max	Units
Frequency	27		31	GHz
Small Signal Gain		23		dB
Pout @ 19dBc NPR		22		W
PAE @ P1dB		24		%
Pout @ P1dB	40	45		W
Return Loss		15		dB
Drain Voltage		28		V
Drain Bias Current		3000		mA

TMC215D 27-31 GHz Linear Power Amplifier

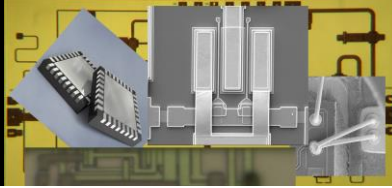

mmTRON
Unleashing the
mmWave Frontier

*Off chip bypassing for each supply pad 100pF to minimize components. Decades of capacitance from 100pF to 10uF for best linearity. Device should have DC applied from both top and bottom on all pads. Number of 1-mil bondwires per pad is as follows. VG1, VG2 and VG3: 1, VD1: 2, VD2: 3, VD3: 6.

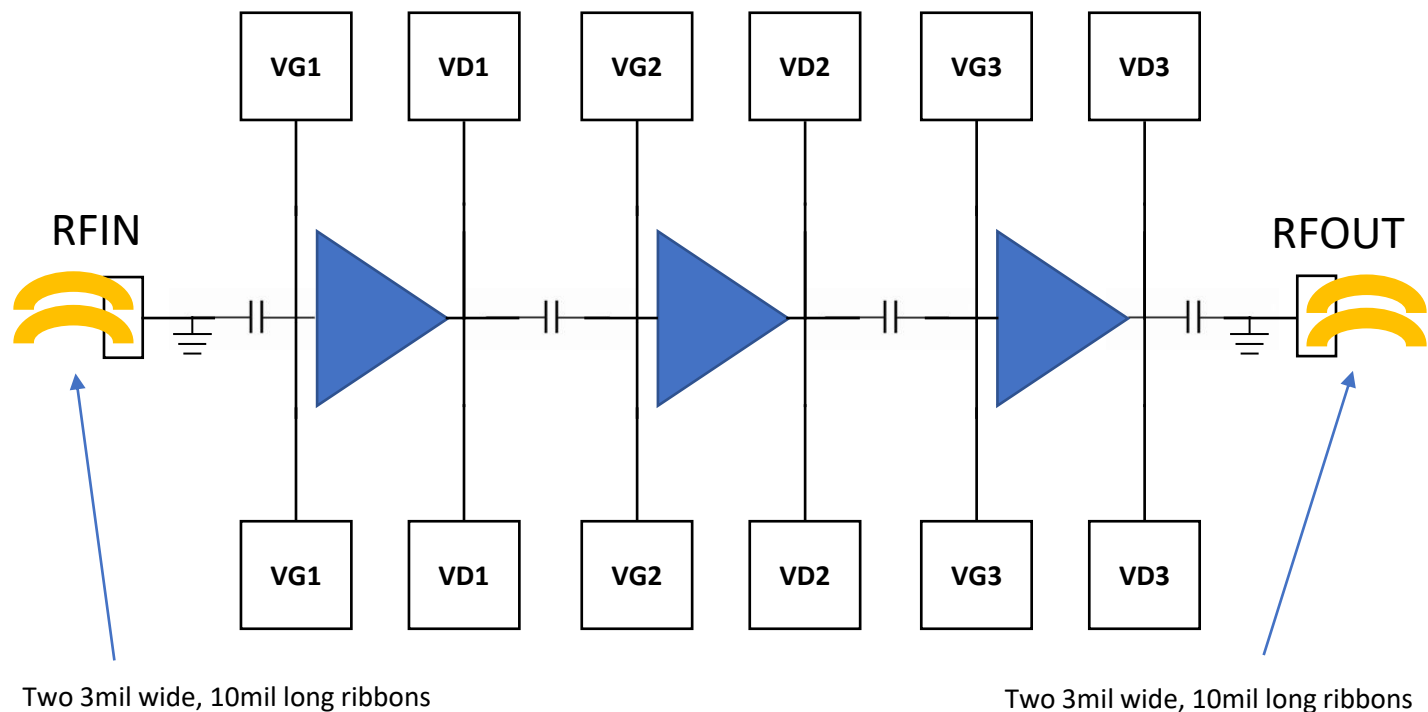

Bias Sequencing: To turn ON the device, VG1, VG2 and VG3 are first set at -6V. Then set VD1, VD2 and VD3 to 28V. Finally, adjust VG1 = VG2 = VG3 to achieve ID_total = 3000mA. To turn OFF the device, you set VG1, VG2 and VG3 to -6V, then turn off the VD1, VD2 and VD3 followed by turning off VG1, VG2 and VG3.

TMC215D 27-31 GHz Linear Power Amplifier

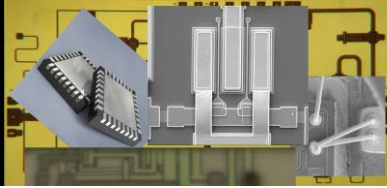

mmTRON
Unleashing the
mmWave Frontier

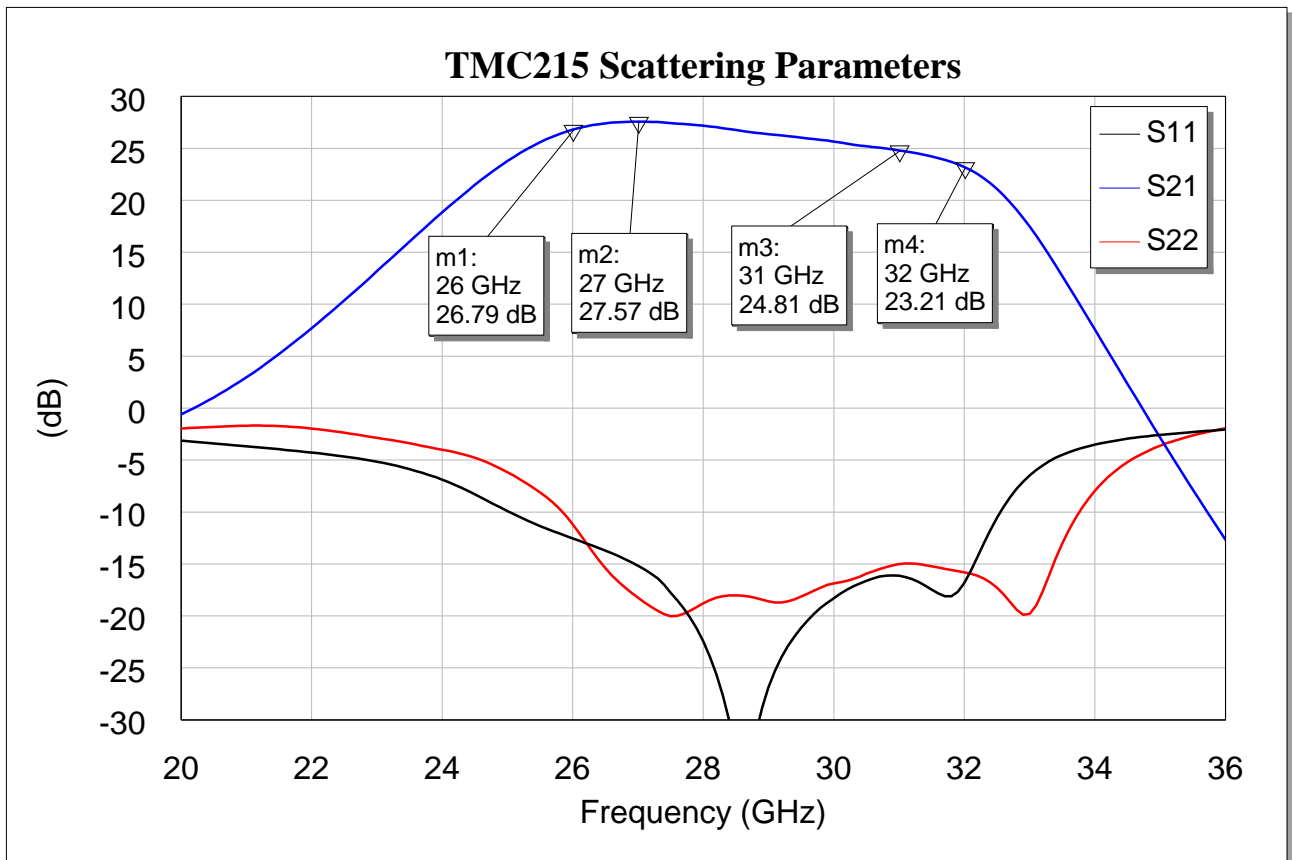

*VD1 = VD2 = VD3 = 28V, ID_total = 3000mA, Tamb = 25C
On-wafer, pulsed

TMC215D

27-31 GHz

Linear Power Amplifier

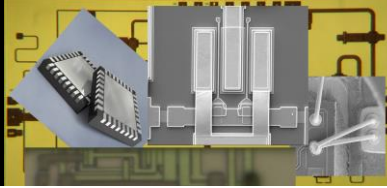

mmTRON
Unleashing the
mmWave Frontier

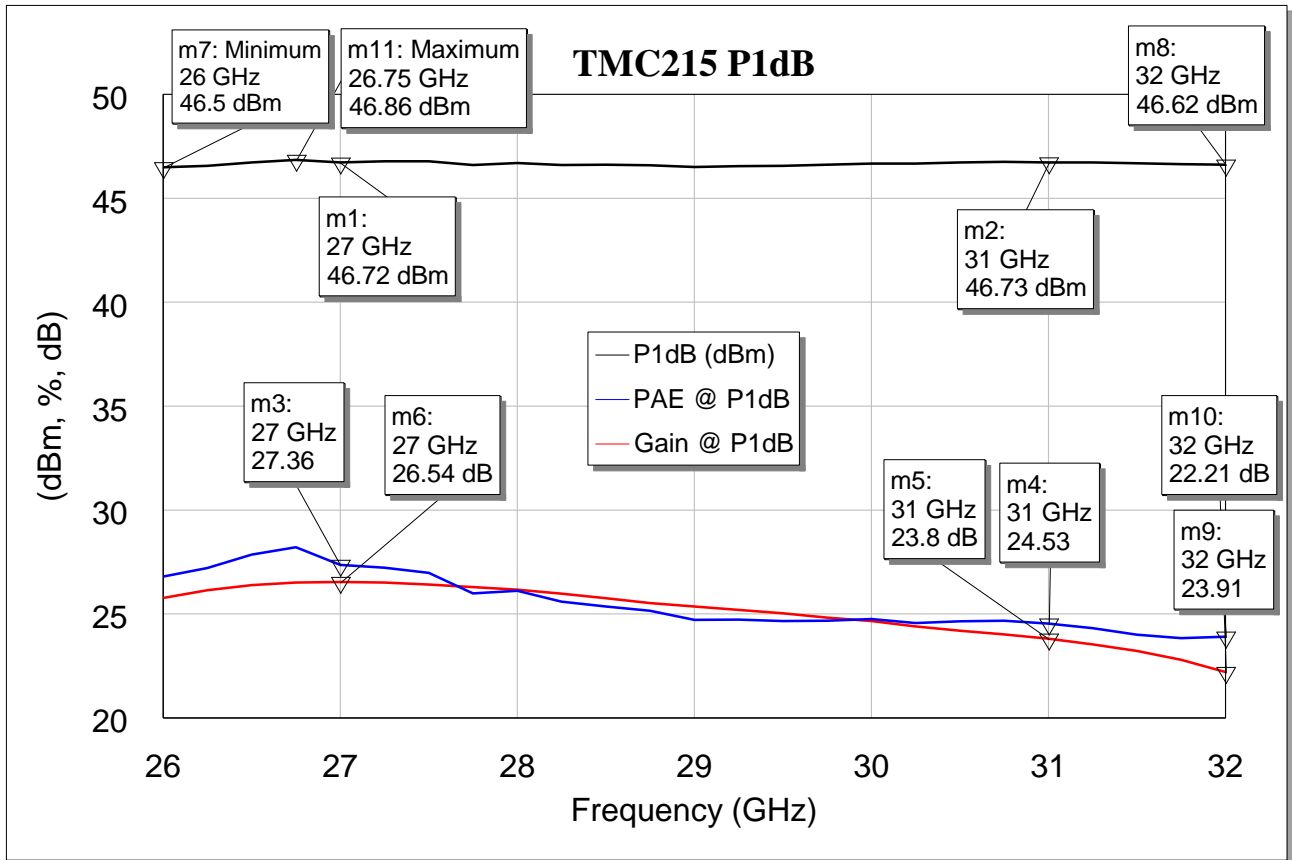

*VD1 = VD2 = VD3 = 28V, ID_total = 3000mA, Tamb = 25C
On-wafer, pulsed

TMC215D

27-31 GHz

Linear Power Amplifier

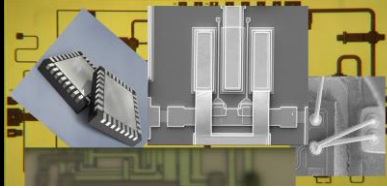

mmTRON
Unleashing the
mmWave Frontier

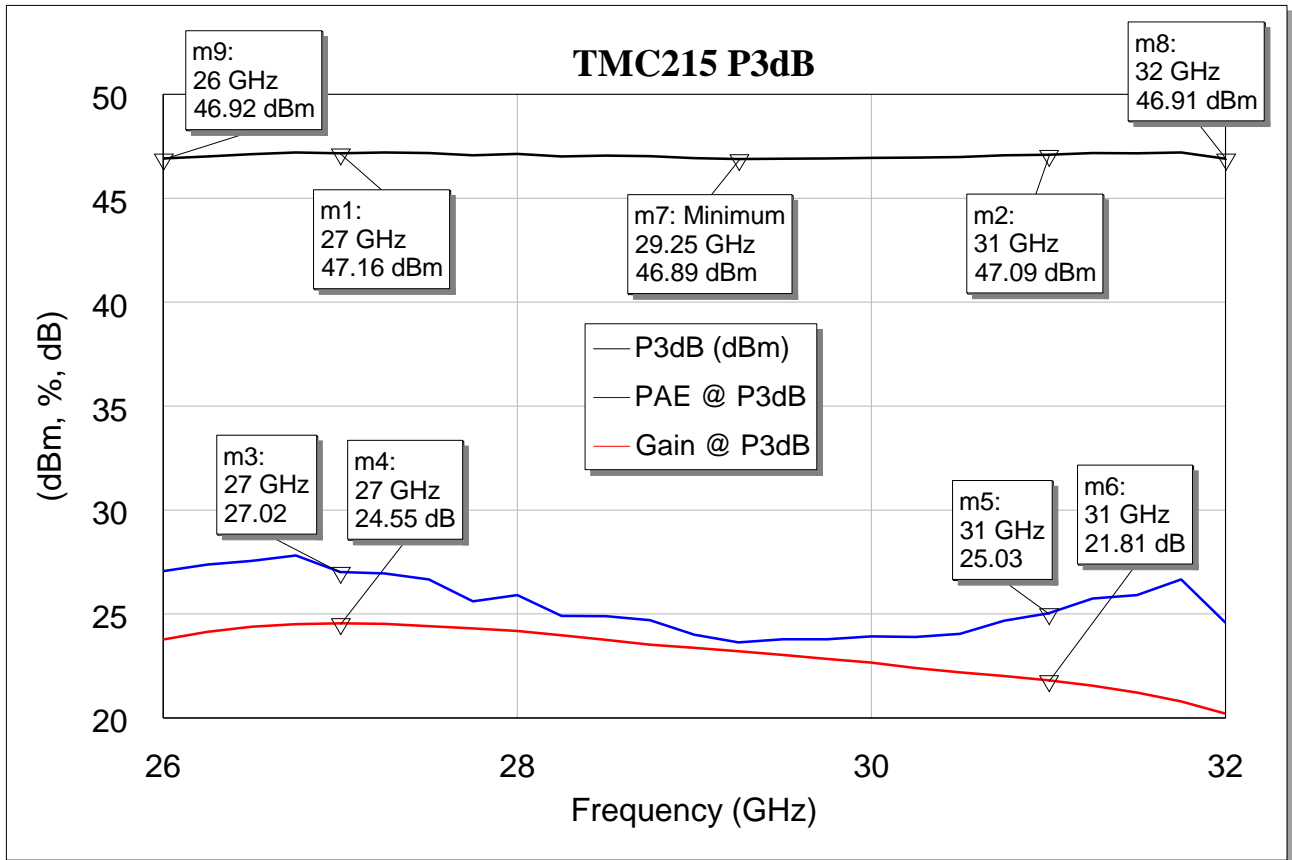

*VD1 = VD2 = VD3 = 28V, ID_total = 3000mA, Tamb = 25C
On-wafer, pulsed

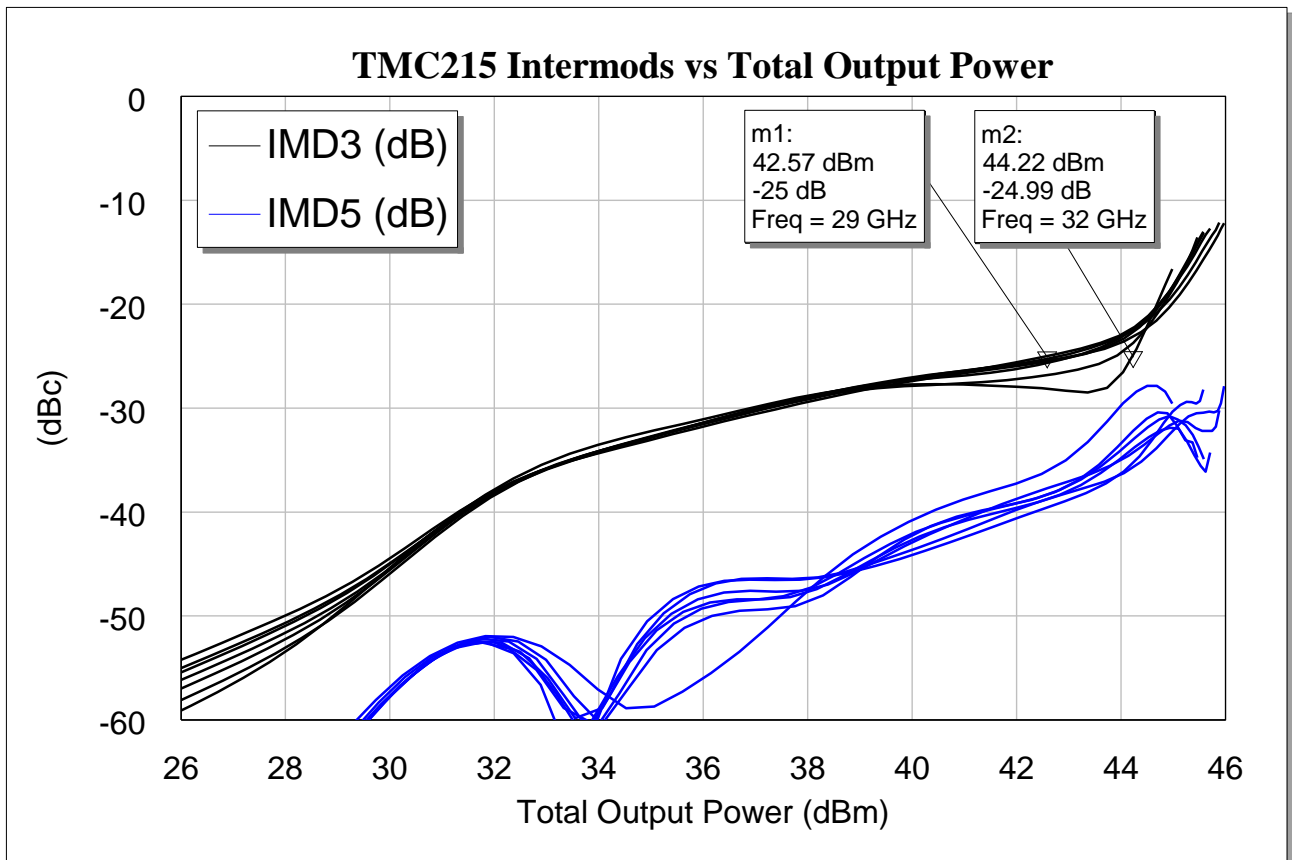
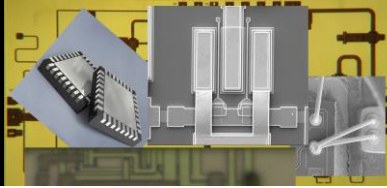

*VD1 = VD2 = VD3 = 28V, ID_total = 3000mA, Tamb = 25C
Tone Spacing = 100 MHz

TMC215D 27-31 GHz Linear Power Amplifier

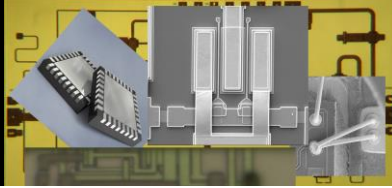

mmTRON
Unleashing the
mmWave Frontier

5GNR (29GHz)

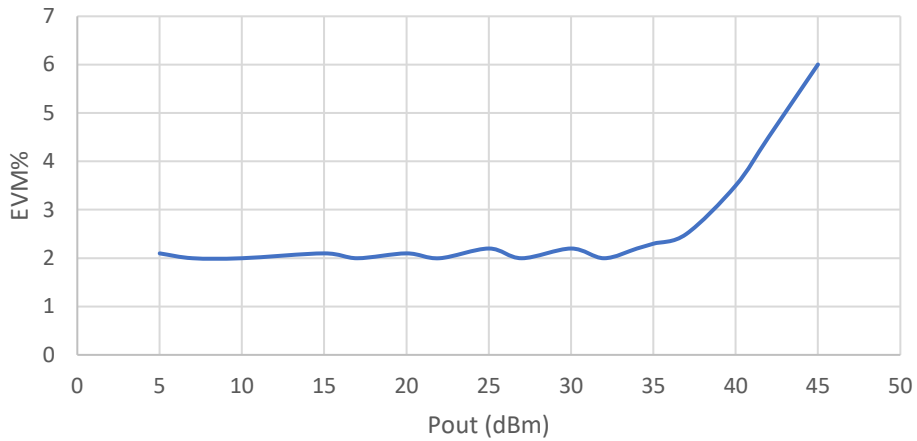

5GNR (29GHz)

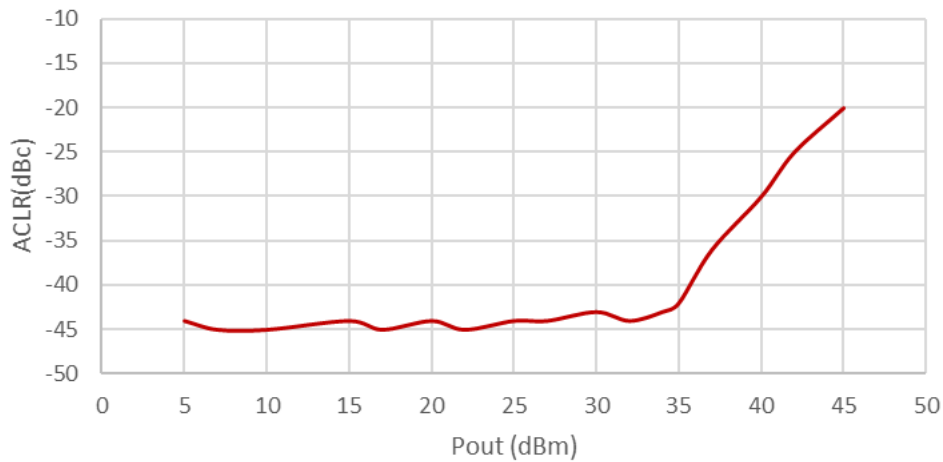

TMC215D

27-31 GHz

Linear Power Amplifier

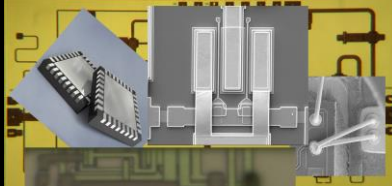

mmTRON
Unleashing the
mmWave Frontier

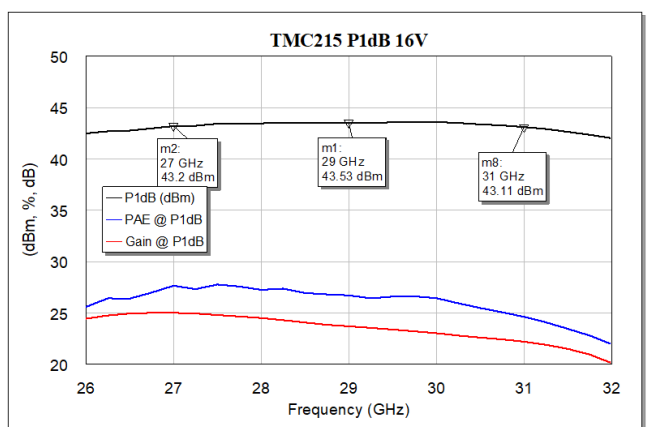
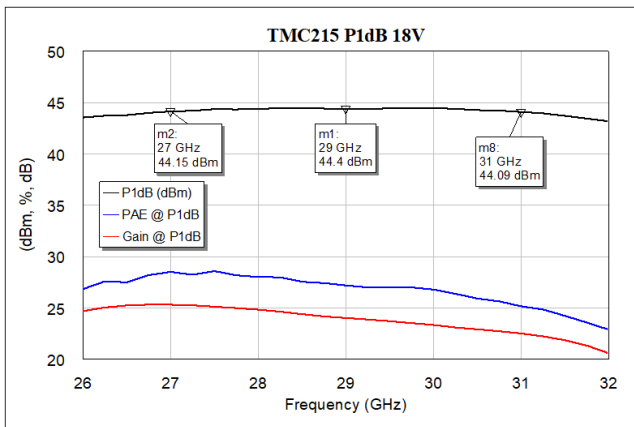
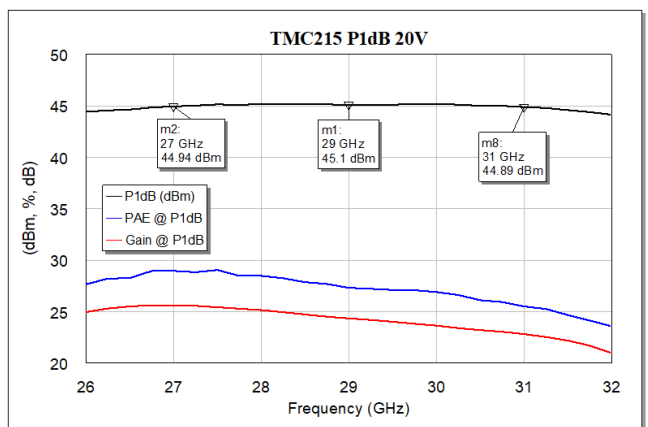
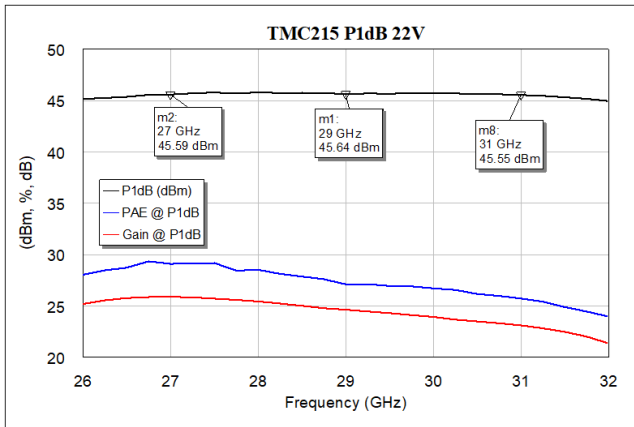
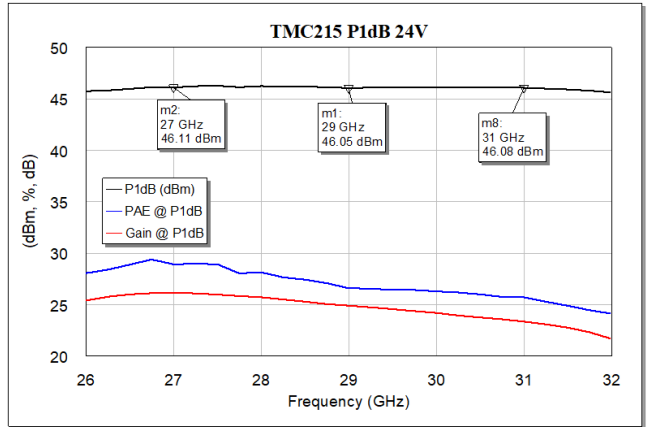
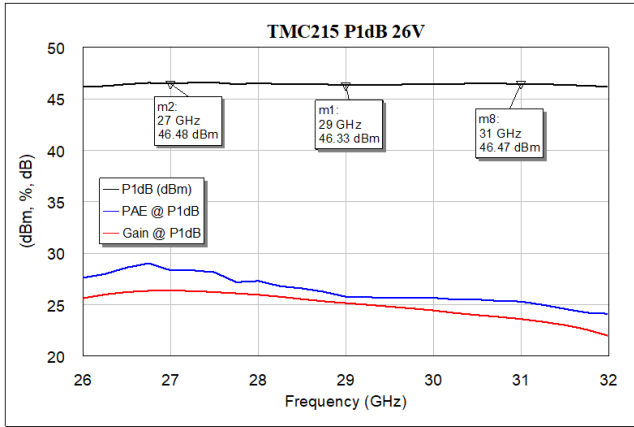

TMC215D

27-31 GHz

Linear Power Amplifier

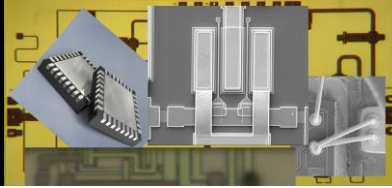

mmTRON
Unleashing the
mmWave Frontier

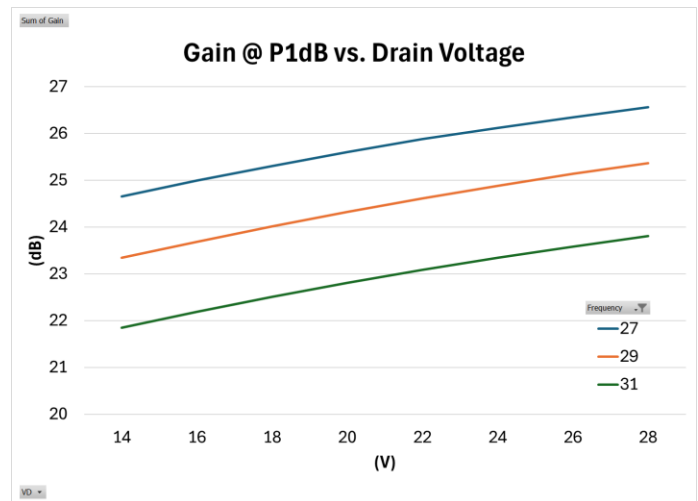
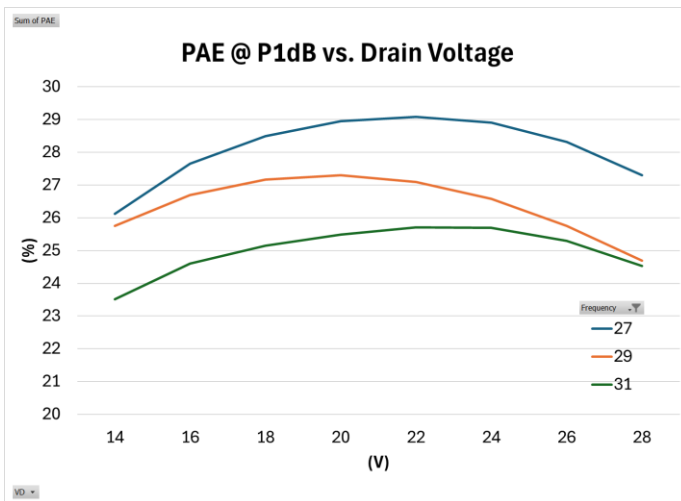
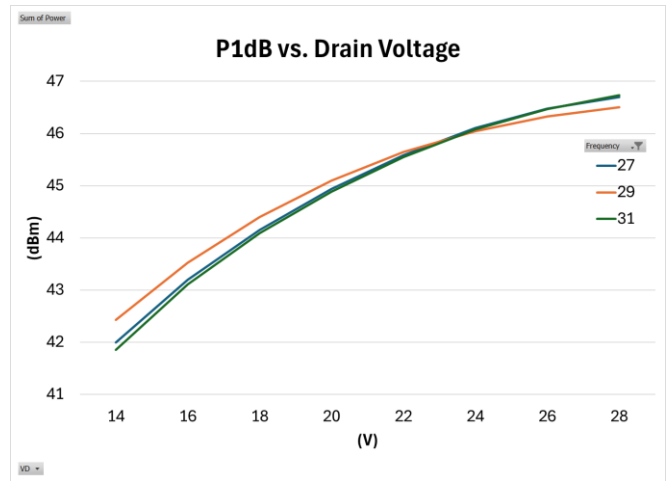
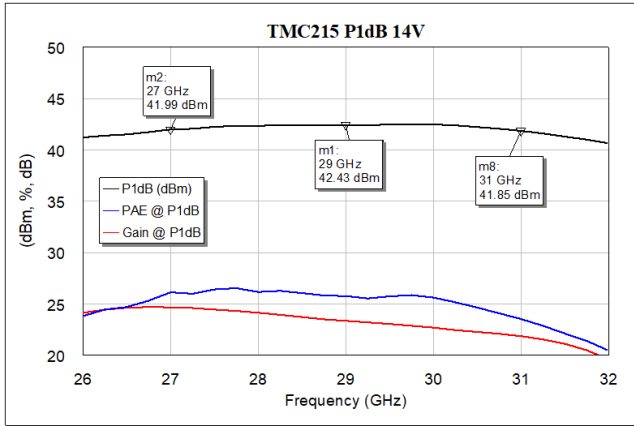

TMC215D 27-31 GHz Linear Power Amplifier

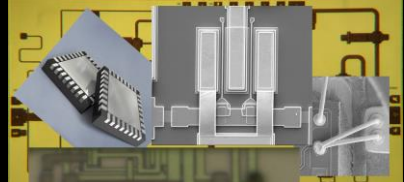

mmTRON
Unleashing the
mmWave Frontier

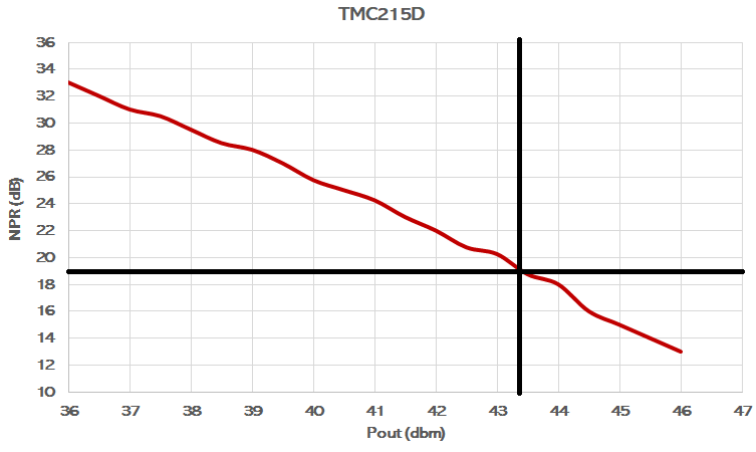

**10MHz Spacing, 2-Tone Measurements, 29 GHz
TMC215, Class AB Bias**

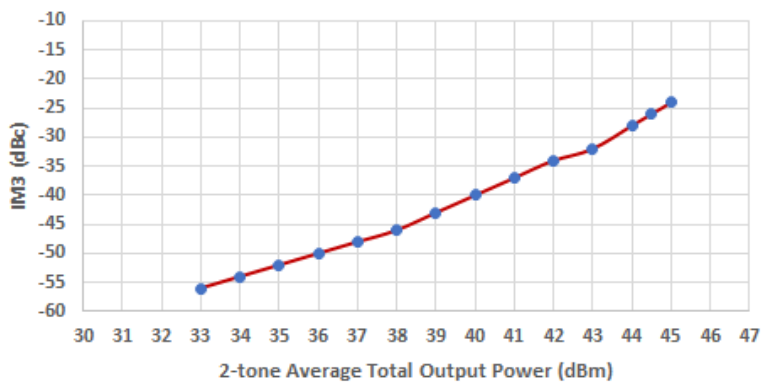

**10MHz Spacing, 2-Tone Measurements, 29 GHz
TMC215, Deep Class AB Bias**

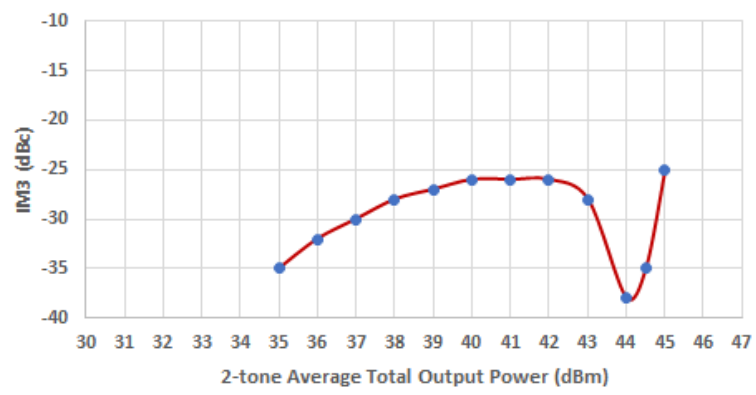

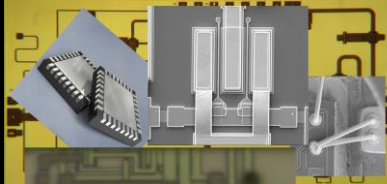

• Recommended Biasing

- The TMC215D is operated with one positive supply VDD (VD1=VD2=VD3) and one negative supply VGG (VG1 = VG2 = VG3). The positive supply must be connected to the VD1, VD2 and VD3 pads on the die. The negative supply must be connected to the VG1, VG2 and VG3 pads on the die. VGG is biased to -6V first, then VDD is gradually biased to +28V and finally, VGG is adjusted to around -3.7V for ID_total = 3000mA DC current.
- Reverse the sequence during power down, i.e. bring VGG to -6V, lower VDD to 0V, and then VGG to 0V.
- Note that VG1, VG2 and VG3 can be separated and controlled independently in order to further improve linearity.

• Assembly Techniques

- The TMC215D is fabricated using a GaN-based semiconductor material structure and may be packaged in an air-cavity QFN or used as a die. The die is designed to allow either epoxy or eutectic attach.

• ESD Warning

- III-V MMICs are ESD-sensitive. Preventative ESD measures must be employed in all aspects of storage, handling, and assembly. MMIC ESD precautions, handling considerations, and die-attach and bonding methods are critical factors in successful III-V MMIC performance and reliability.

• RoHS Compliance

- This part is RoHS compliant, meeting the requirements of the EU Restriction of Hazardous Substances Directive 2002/95/EC, commonly known as RoHS. Six substances are regulated: lead, mercury, cadmium, chromium VI (hexavalent chromium), polybrominated biphenyls (PBB), and polybrominated biphenyl ethers (PBDE). RoHS compliance requires that any residual concentration of these substances is below the Directive's maximum concentration values (MCV): cadmium 100ppm by weight and all others 1000ppm by weight.

TMC215D
27-31 GHz
Linear Power Amplifier

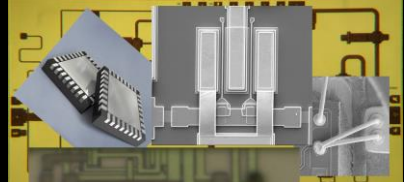

mmTRON
 Unleashing the
 mmWave Frontier

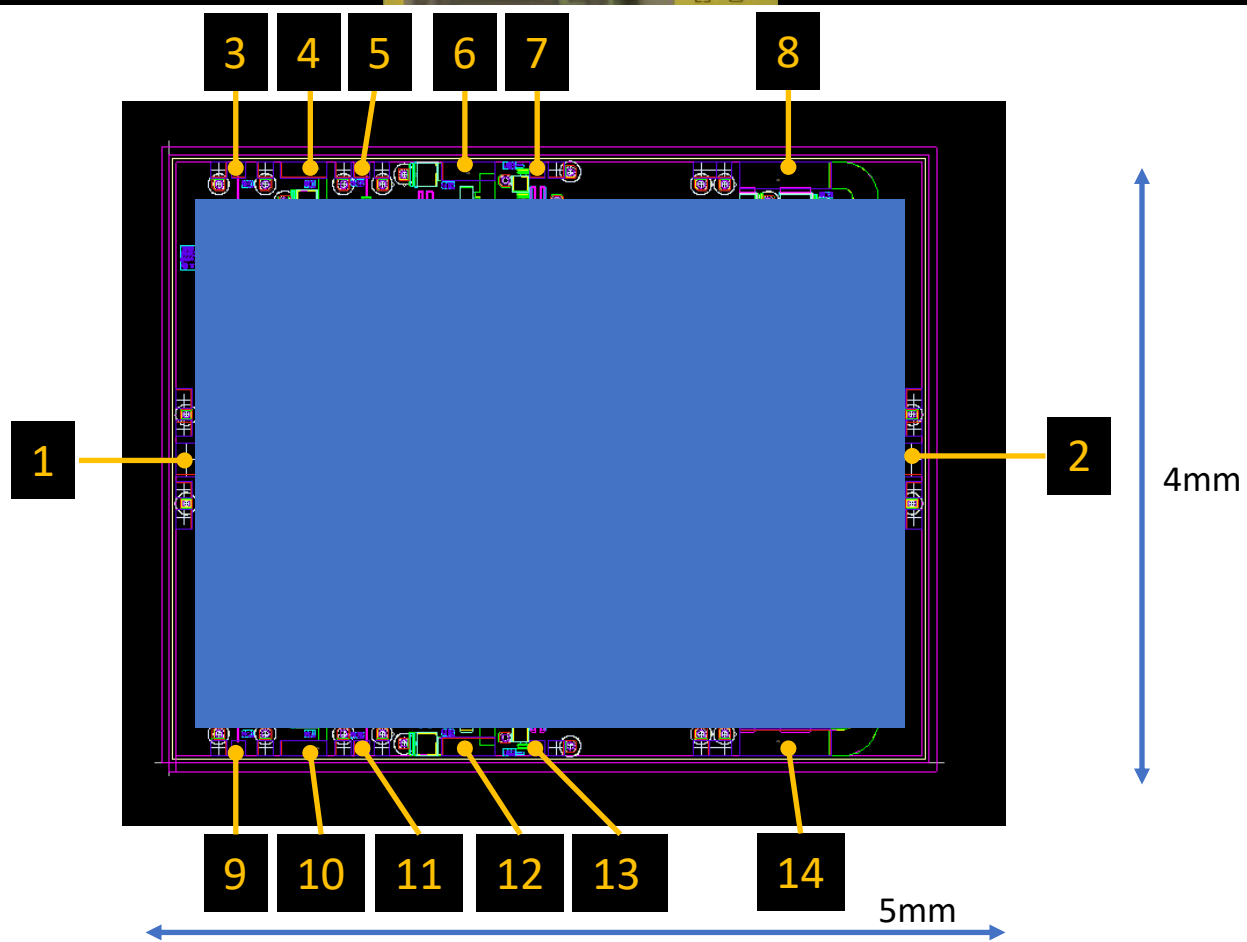

Pad #	Function
1	RFIN
2	RFOUT
3, 9	VG1
4, 10	VD1
5, 11	VG2
6, 12	VD2
7, 13	VG3
8, 14	VD3

TMC215D

27-31 GHz

Linear Power Amplifier

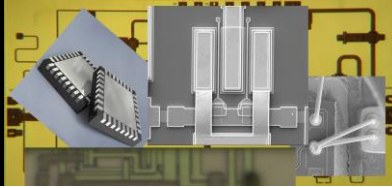

mmTRON
Unleashing the
mmWave Frontier

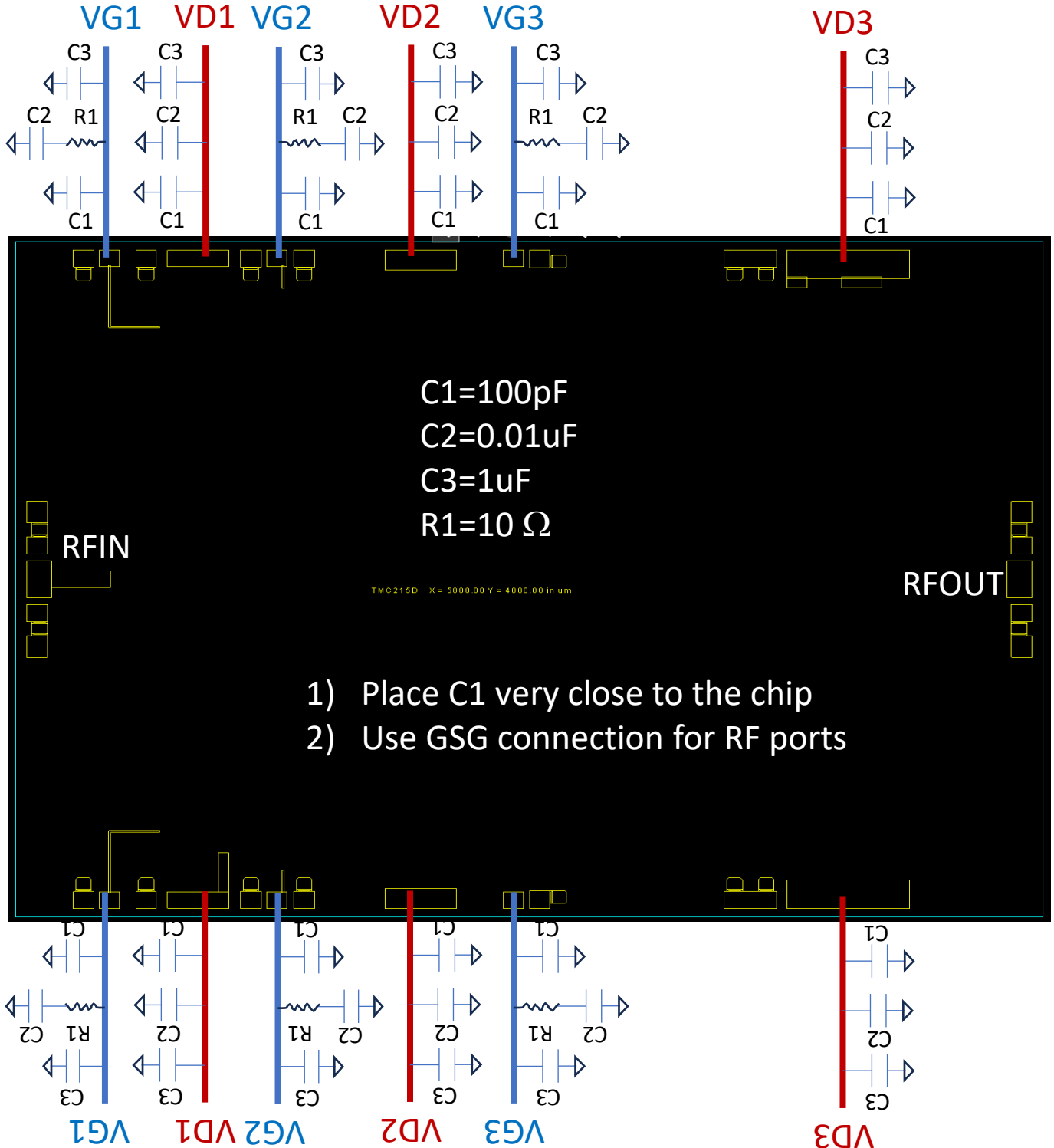

TMC215T 27-31 GHz Linear Power Amplifier

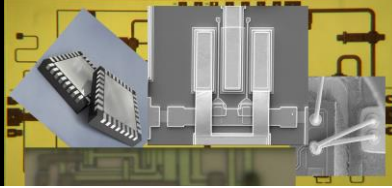

mmTRON
Unleashing the
mmWave Frontier

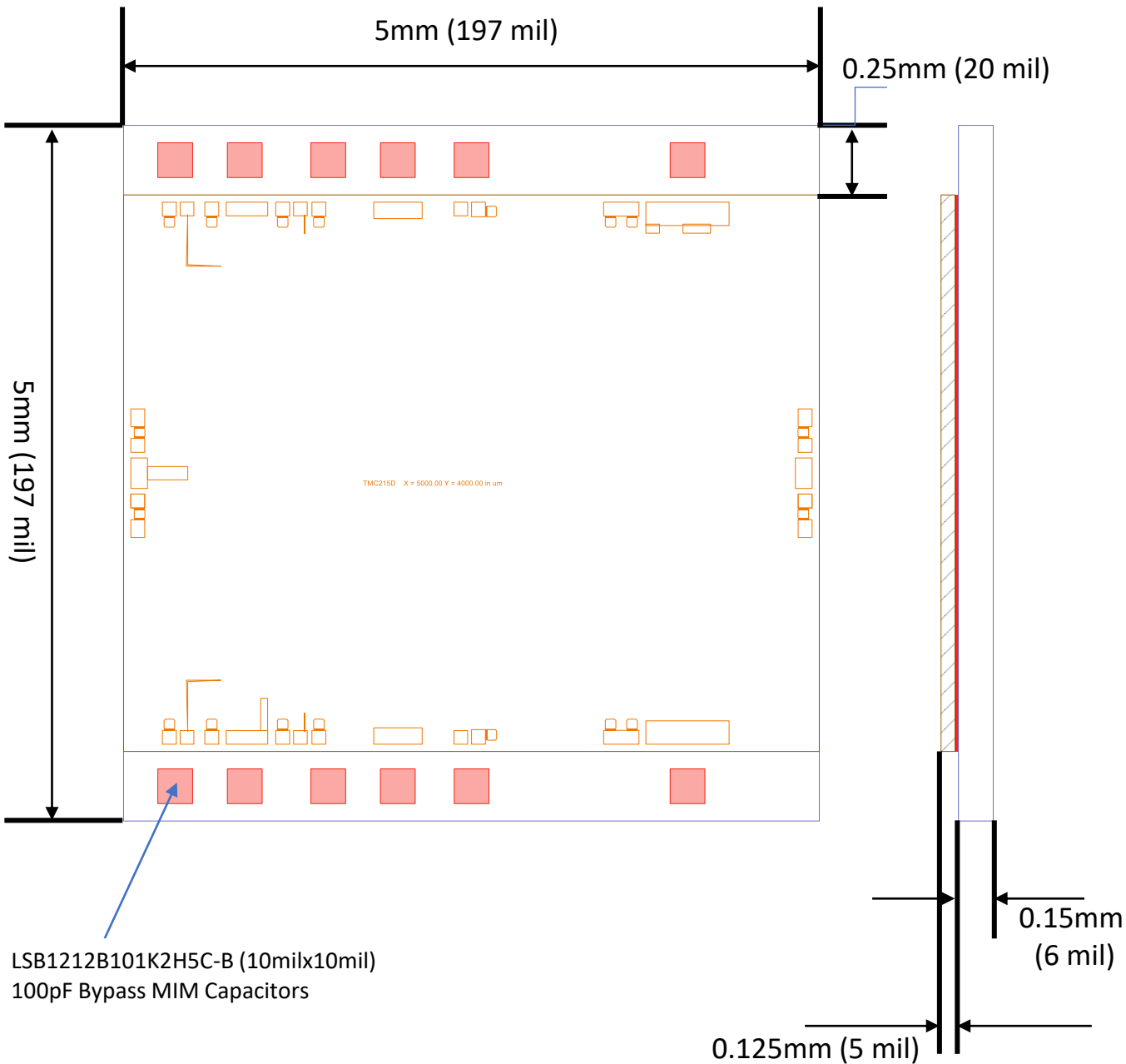

1. Dimensions are in mm(mil)
2. **Thermal spreader TAB material: 89W-11Cu**
3. Plating: Ni/Gold
4. AuSn die attach (Ag Epoxy is also available)

TMC215T 27-31 GHz Linear Power Amplifier

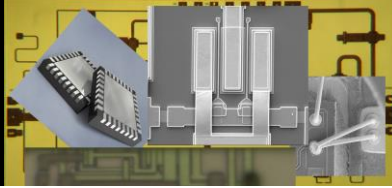

mmTRON
Unleashing the
mmWave Frontier

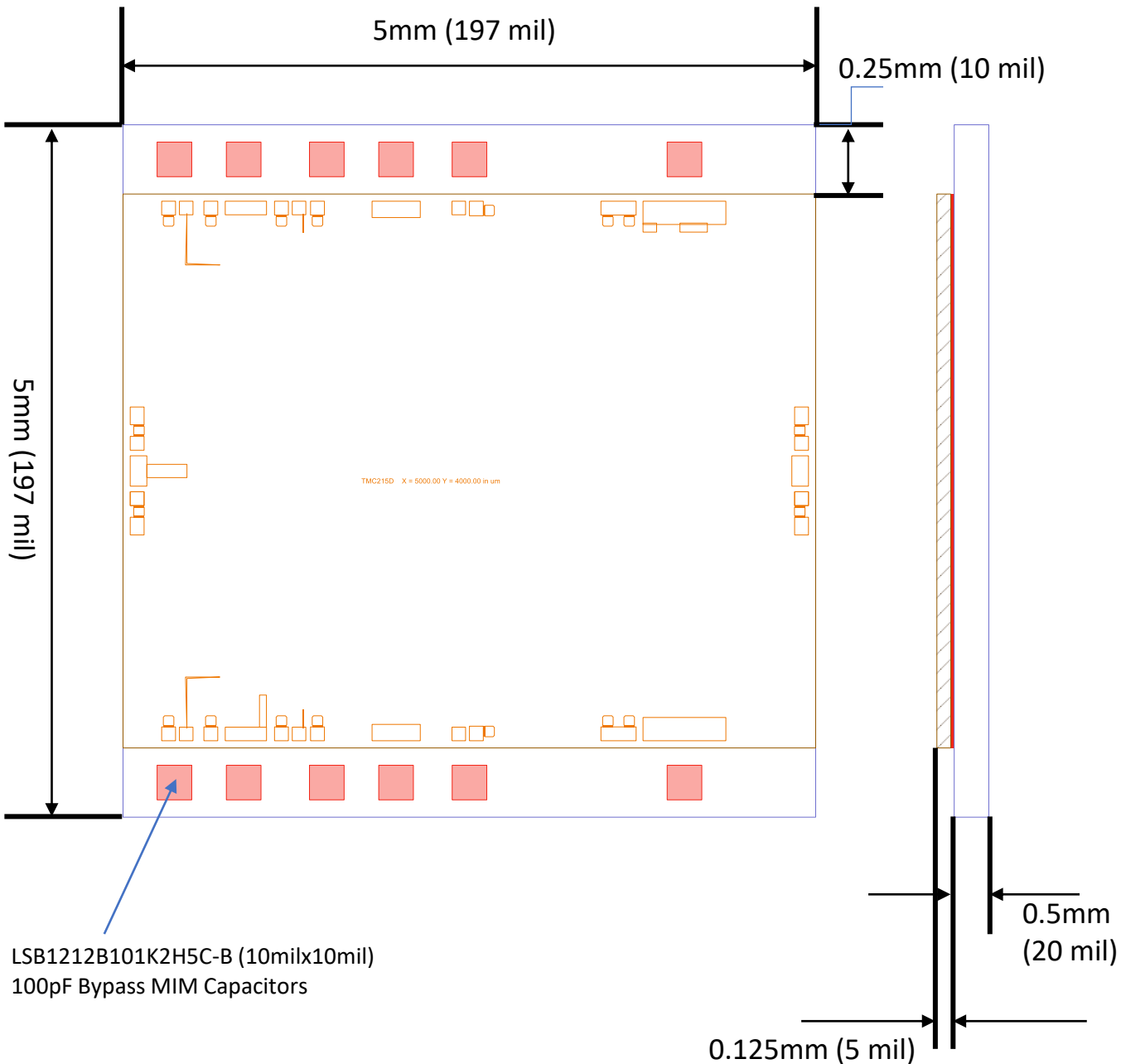

1. Dimensions are in mm(mil)
2. **Thermal spreader TAB material: CuMoCu**
3. Plating: Ni/Gold
4. AuSn die attach (Ag Epoxy is also available)

TMC215T 27-31 GHz Linear Power Amplifier

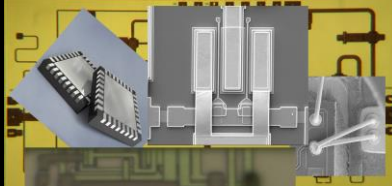

mmTRON
Unleashing the
mmWave Frontier

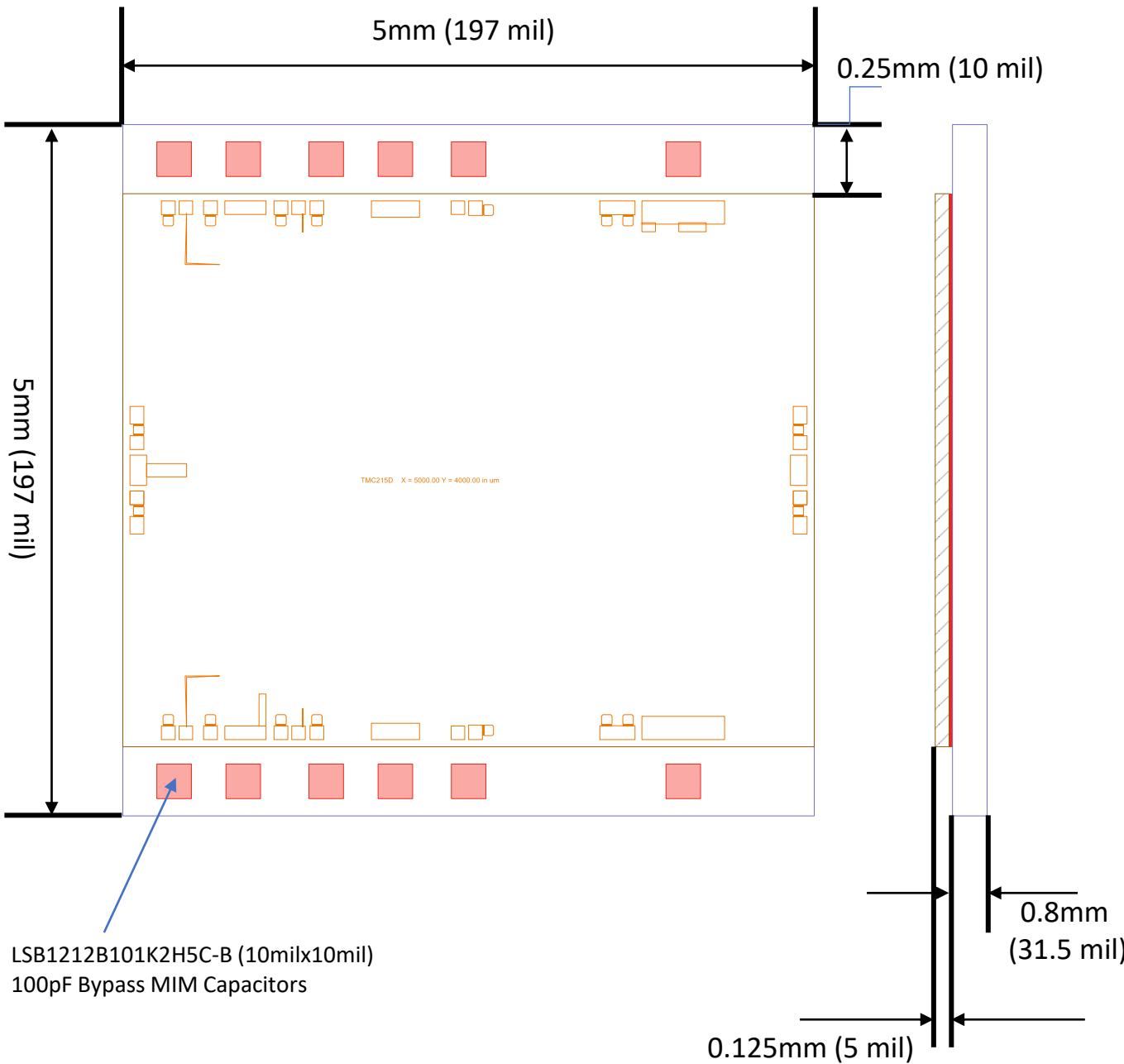

1. Dimensions are in mm(mil)
2. **Thermal spreader TAB material: Ag-Diamond**
3. Plating: Ni/Gold
4. AuSn die attach (Ag Epoxy is also available)

TMC215

27-31 GHz

Linear Power Amplifier

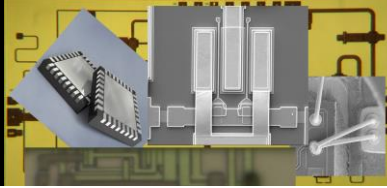

mmTRON
Unleashing the
mmWave Frontier

Parameter	Condition (Bare Die)	Value	Unit
Thermal Resistance	P _{out} =45.3dBm (34W), Frequency=27 GHz VDD=28 V, IDQ=3A → IDRF=4.86A	0.91	°C/W
Junction Temperature	T _{backside} =85 °C, P _{diss} =102 W	177.8	°C

Parameter	Condition (Bare Die)	Value	Unit
Thermal Resistance	P _{out} =47.2dBm (52W), Frequency=27 GHz VDD=28 V, IDQ=3A → IDRF=6.69A	0.83	°C/W
Junction Temperature	T _{backside} =85 °C, P _{diss} =135.6 W	197.5	°C

	Value	Unit
TMC215D (Bare Die)	0.83	°C/W
TMC215T (AgDiamond)	0.88	°C/W
TMC215T (CuMoCu)	0.90	°C/W
TMC215T (CuW)	0.93	°C/W

TMC215D 27-31 GHz Linear Power Amplifier

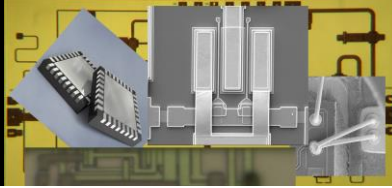

mmTRON
Unleashing the
mmWave Frontier

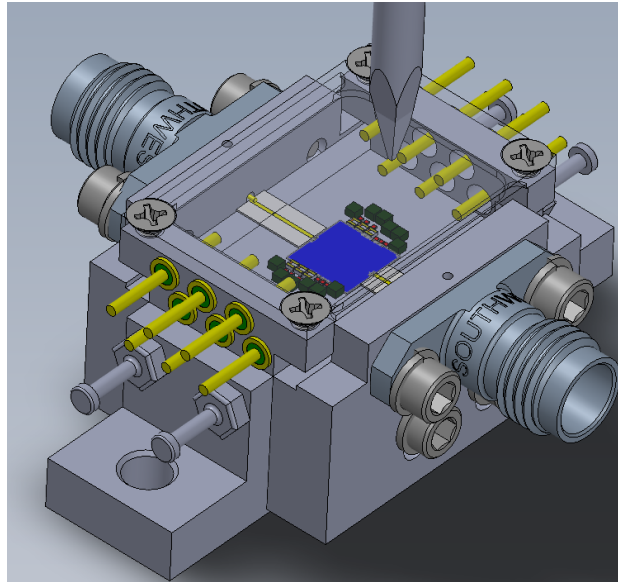

TMC215EVB
Evaluation
Module

TMC215D 27-31 GHz Linear Power Amplifier

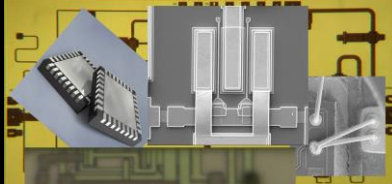

mmTRON
Unleashing the
mmWave Frontier

mmTron Inc. (“mmTron”). All rights reserved.

The information contained in this this datasheet is for reference only. All specifications are subject to change without prior notice.

Except as provided in its Terms and Conditions of Sale or any separate agreement, mmTron assumes no liability or responsibility whatsoever, including for (i) errors or omissions in these materials; (ii) failure to update these materials; or (iii) conflicts or incompatibilities arising from future changes to specifications and product descriptions, which mmTron may make at any time, without notice. These materials grant no license, express or implied, to any intellectual property rights. THESE MATERIALS ARE PROVIDED "AS IS" WITH NO WARRANTY OR LIABILITY, EXPRESS OR IMPLIED, RELATING TO SALE AND/OR USE OF mmTron PRODUCTS INCLUDING FITNESS FOR A PARTICULAR PURPOSE, MERCHANTABILITY, INFRINGEMENT OF INTELLECTUAL PROPERTY RIGHT, ACCURACY OR COMPLETENESS, OR SPECIAL, INDIRECT, INCIDENTAL, OR CONSEQUENTIAL DAMAGES WHICH MAY RESULT FROM USE OF THESE MATERIALS. mmTron products are not intended for use in medical, lifesaving or life sustaining applications. mmTron customers using or selling mmTron products for use in such applications do so at their own risk and agree to fully indemnify mmTron for any damages resulting from such improper use or sale. These items are controlled by the U.S. Government and authorized for export only to the country of ultimate destination for use by the ultimate consignee or end-user(s) herein identified. They may not be resold, transferred, or otherwise disposed of, to any other country or to any person other than the authorized ultimate consignee or end-user(s), either in their original form or after being incorporated into other items, without first obtaining approval from the U.S. government or as otherwise authorized by U.S. law and regulations’.

The product layout, and specification are mmTron Proprietary and confidential information. The recipient agrees not to copy, alter, modify, reverse engineer, or attempt to derive the composition or underlying information, structure or ideas of any Confidential Information and must not remove, overprint, deface or change any notice of confidentiality, copyright, trademark, logo, legend or other notices of ownership from any originals or copies of mmTron’s information.