

## Product Features

- RF frequency: DC to 28 GHz
- Linear Gain: 15 dB
- $P_{sat}$ : 2.5 W
- Die Size: X=3 mm, Y=1.9 mm, Z=0.1mm
- DC Power: 15 VDC, 550 mA

## Application

- Point-to-Point Radios and VSATs
- Test instrumentation
- Fiber Optics
- Military, EW and Space

## Product Description

The TMC200D GaAs PHEMT Distributed amplifier is a broadband device, designed for use in Radios, Test instrumentation, Military, EW and Space applications. The TMC200D is a 50  $\Omega$  matched design with positive gain slope providing 2.5W of saturated power to 28 GHz, excellent power added efficiency and eliminates the need for RF port matching. The typical bias for TMC200D is 10-15V and 450-550mA but it can be biased to as low as 8V and 300mA with excellent performance. Both bond pad and backside metallization are Au-based that is compatible with ribbon and wedge bonding and high conductivity epoxy and eutectic die attach methods.

### *Electrical Performance : Vdd = 15 V, Vgg = -0.5 V, TA = 25 °C, F = 20 GHz*

	min	Typ	Max	Units
<b>Frequency</b>	DC		28	GHz
<b>Gain</b>		15		dB
<b>P1dB</b>		33		dBm
<b>Psat</b>		34		dBm
<b>Noise Figure</b>		3.5		dB
<b>OIP3</b>		43		dBm
<b>Bias Voltage</b>		15		V
<b>Bias Current</b>		550		mA

**TMC200D**  
**DC-28 GHz**  
**Distributed Power Amplifier**

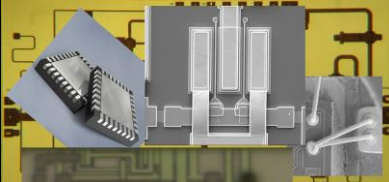

**mmTRON**  
 Unleashing the  
 mmWave Frontier

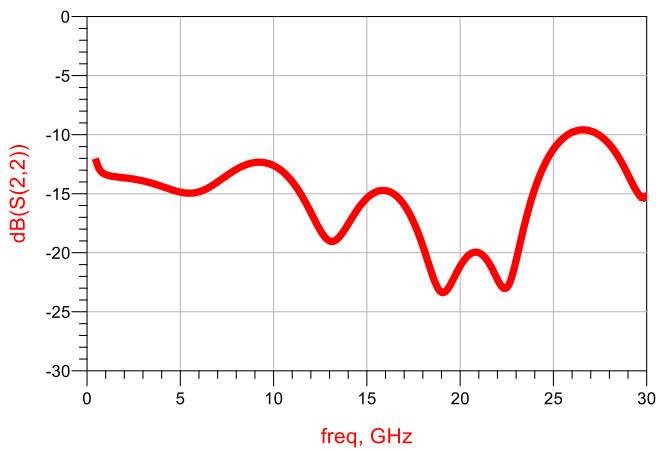
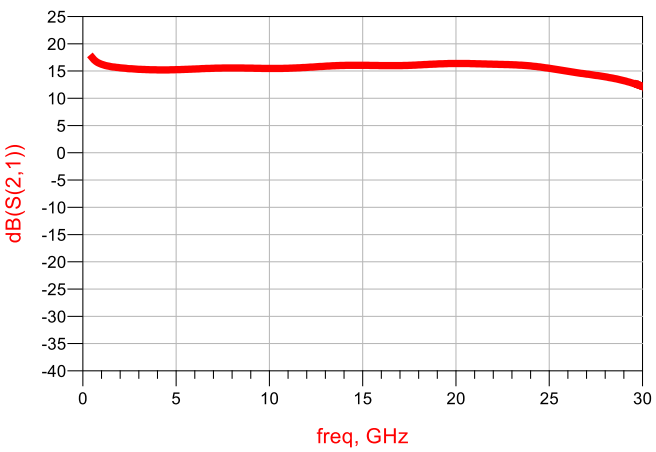
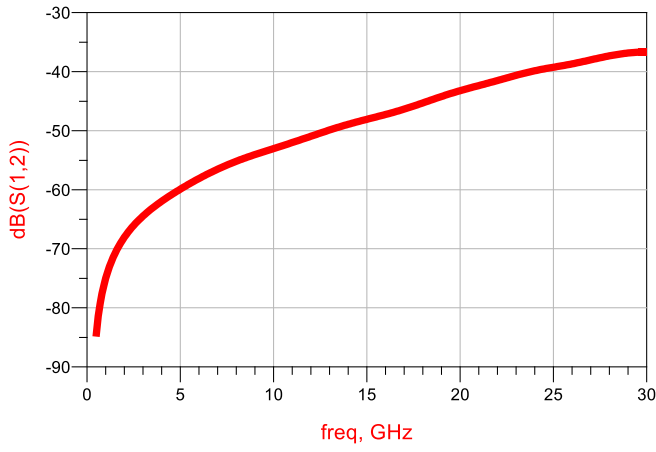
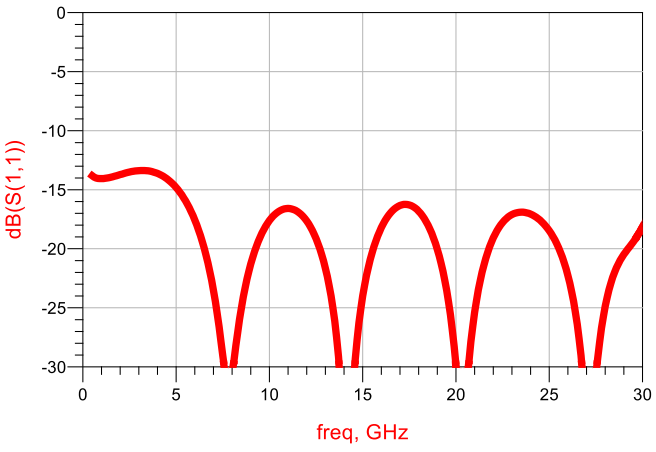

TMC200 Psat

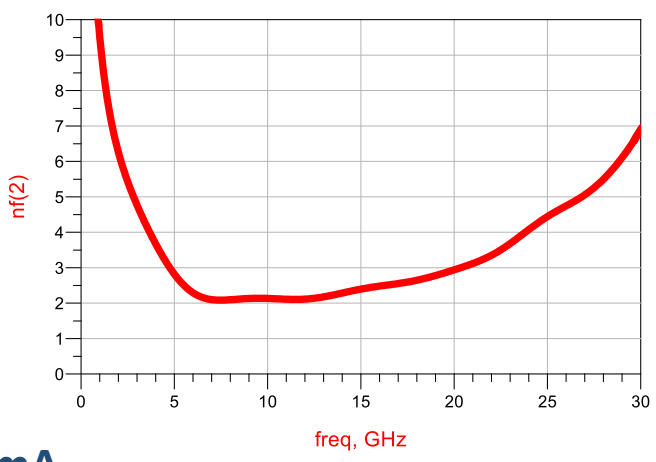
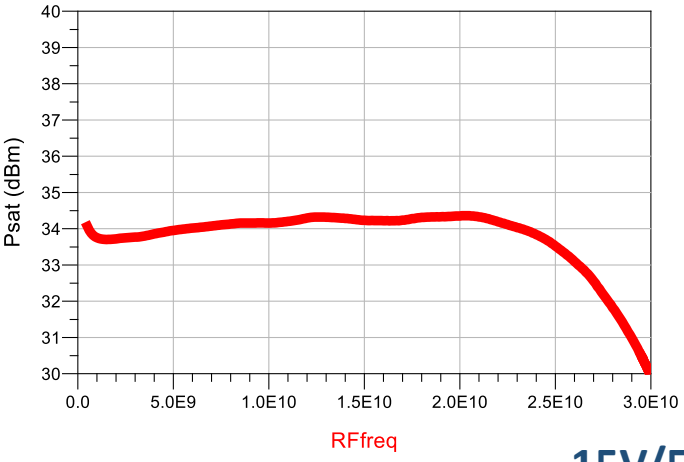

**15V/550mA**

**TMC200D**  
**DC-28 GHz**  
**Distributed Power Amplifier**

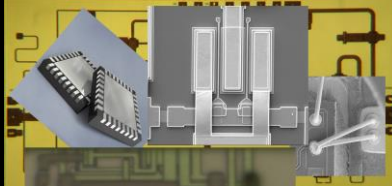

**mmTRON**  
 Unleashing the  
 mmWave Frontier

TMC200 Input Return Loss

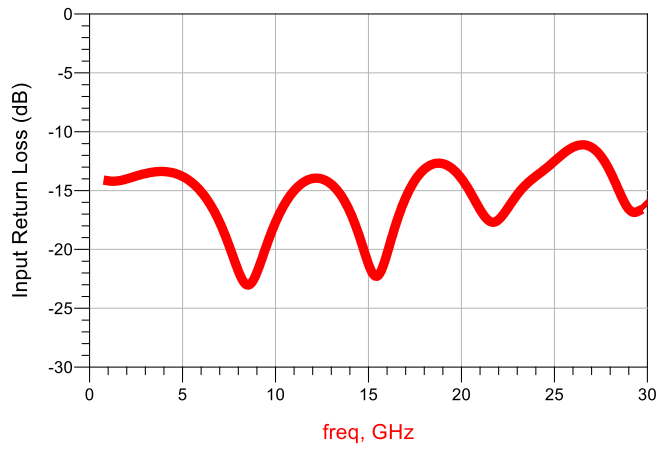

TMC200 Reverse Isolation

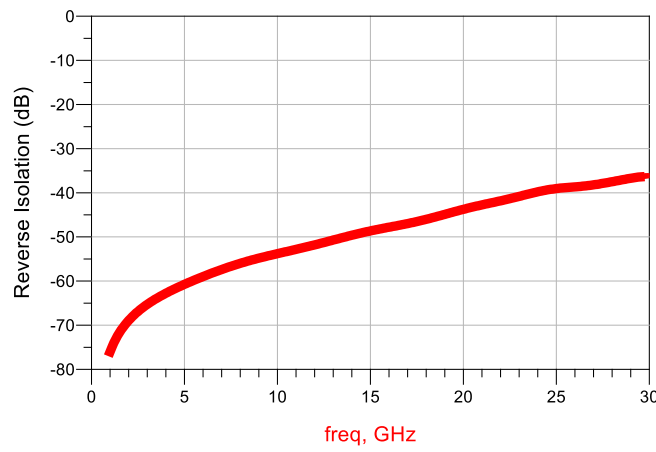

TMC200 Gain

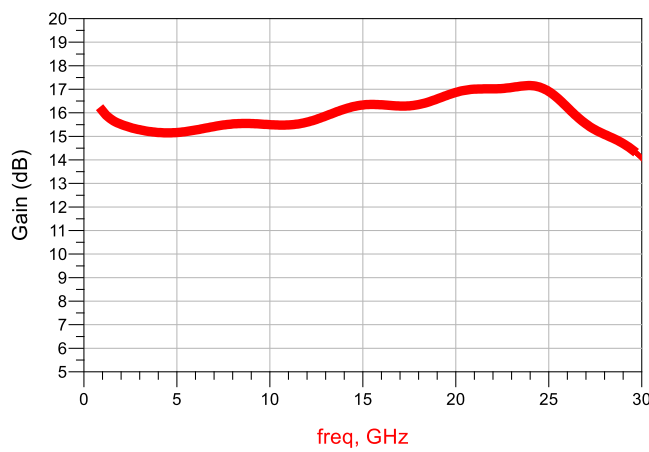

TMC200 Output Return Loss

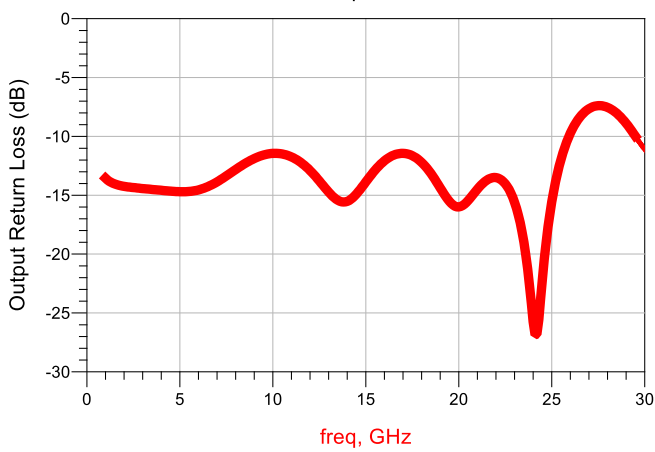

TMC200 Psat

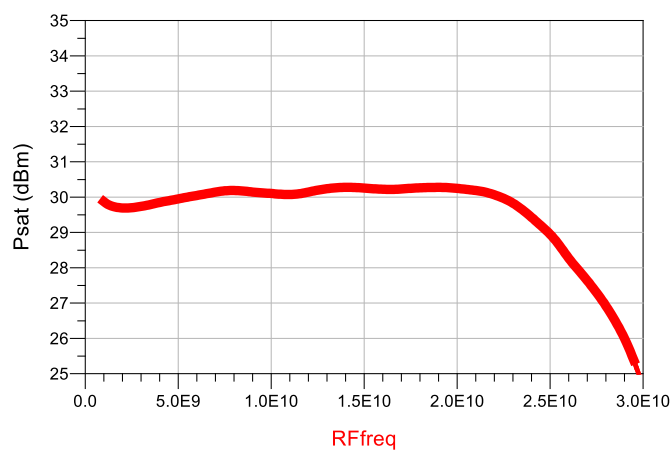

TMC200 Noise Figure

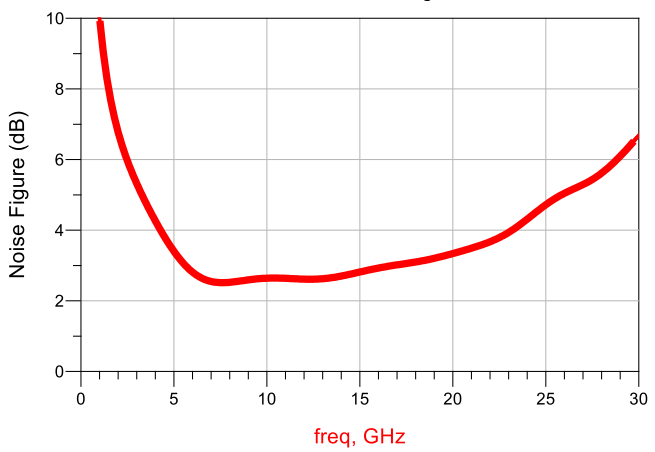

**10V/500mA**

**TMC200D**  
**DC-28 GHz**  
**Distributed Power Amplifier**

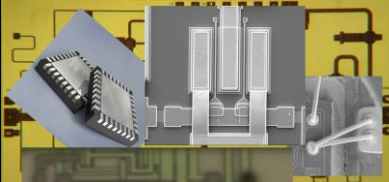

**mmTRON**  
 Unleashing the  
 mmWave Frontier

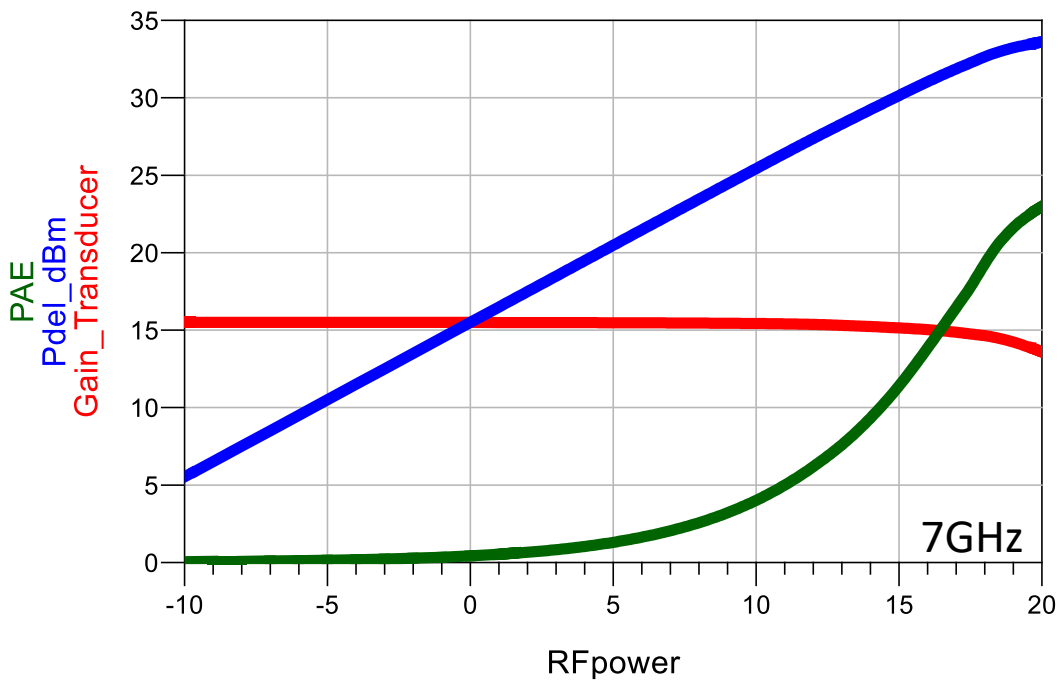
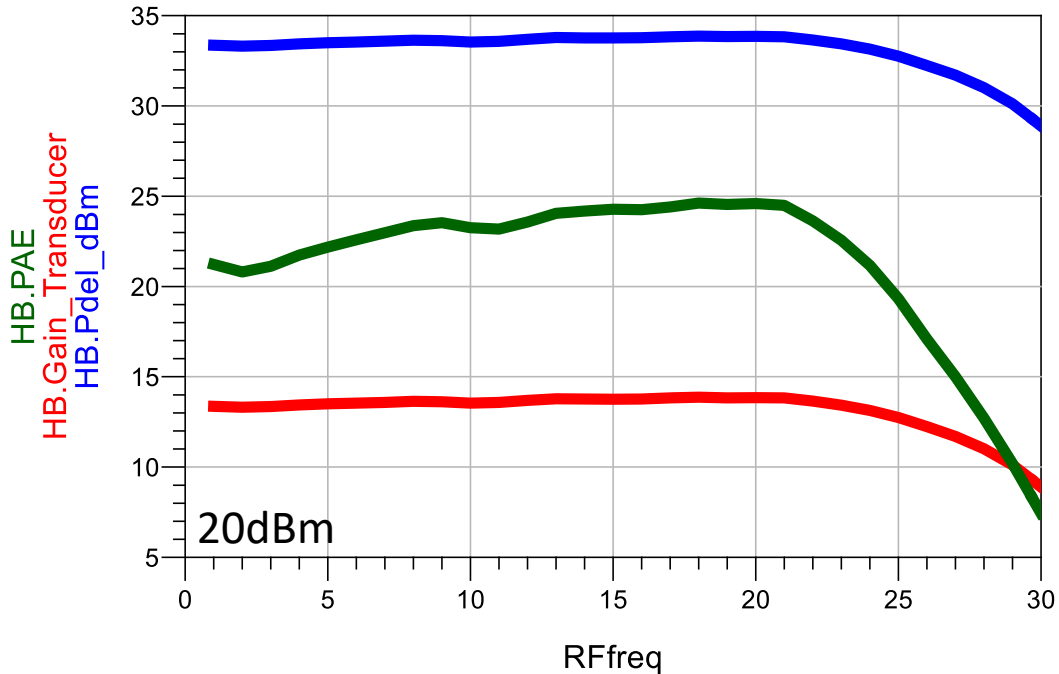

# TMC200D

## DC-28 GHz Distributed Power Amplifier

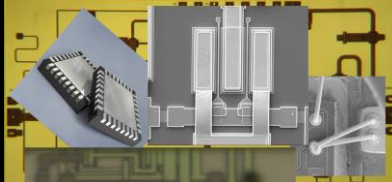

**mmTRON**  
Unleashing the  
mmWave Frontier

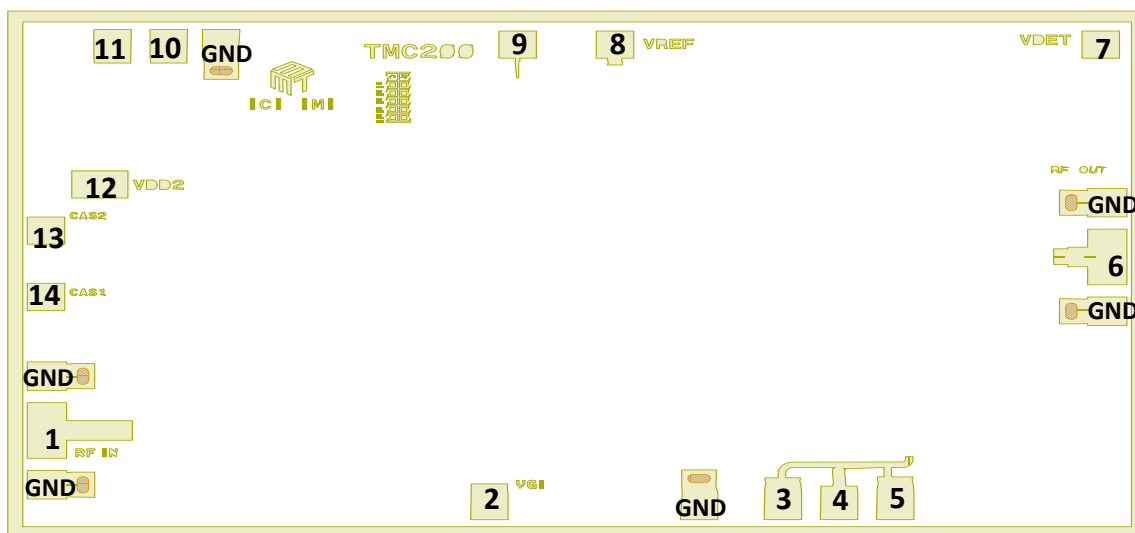

Pad #	Function	Description
1	RF INPUT	This pad is DC coupled and matched to 50 Ohms. Blocking capacitor is required.
2	VGG1 Bias	Gate control 1 for amplifier. Attach 100pF/0.01uF/4.7uF bypass capacitors.
3	ACG4	Low frequency termination. Attach 100pF chip bypass capacitor.
4	ACG3	Low frequency termination. Attach 0.01uF chip bypass capacitor.
5	ACG5	Low frequency termination. Attach 4.7uF chip bypass capacitor.
6	RF OUTPUT & VDD	RF output for amplifier. Connect DC bias (Vdd) network to provide drain current (Idd).
7	VDET	Temperature compensated power detector output voltage. This provides a voltage which is proportional to the output power of the amplifier.
8	VREF	Detector DC Offset Voltage
9	VREF_VDC	Detector VDC. Used in conjunction with VREF for common mode cancellation of diode temperature drift and good log linearity versus power
10	ACG2	Low frequency termination. Attach 0.01uF/4.7uF chip bypass capacitor.
11	ACG1	Low frequency termination. Attach 0.01uF chip bypass capacitor.
12	VDD2	Optional: Second connection for DC bias (Vdd) network to provide a 2 <sup>nd</sup> path for drain current (Idd) for higher power applications. See application circuit herein.
13	VGG2 (VCAS2)	Gate 3 for amplifier. Attach 100pF/0.01uF/4.7uF chip bypass capacitors. Typical operation has VGG3(VCAS2) biased internal to IC. Setting VGG3 externally can be used to adjust NF, Gain and OIP3.
14	VGG2 (VCAS1)	Gate 2 for amplifier. Optional: Attach 100pF/0.01uF/4.7uF chip bypass capacitors. Typical operation has VGG2(VCAS1) biased internal to IC. Setting VGG2 externally can be used to adjust NF, Gain and OIP3.

- DXF and detailed assembly drawings are available on request.

# TMC200D

## DC-28 GHz Distributed Power Amplifier

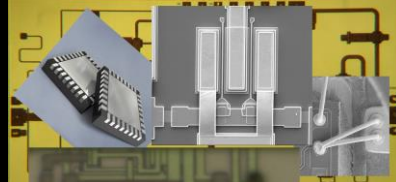

**mmTRON**  
Unleashing the mmWave Frontier

### Assembly Diagram

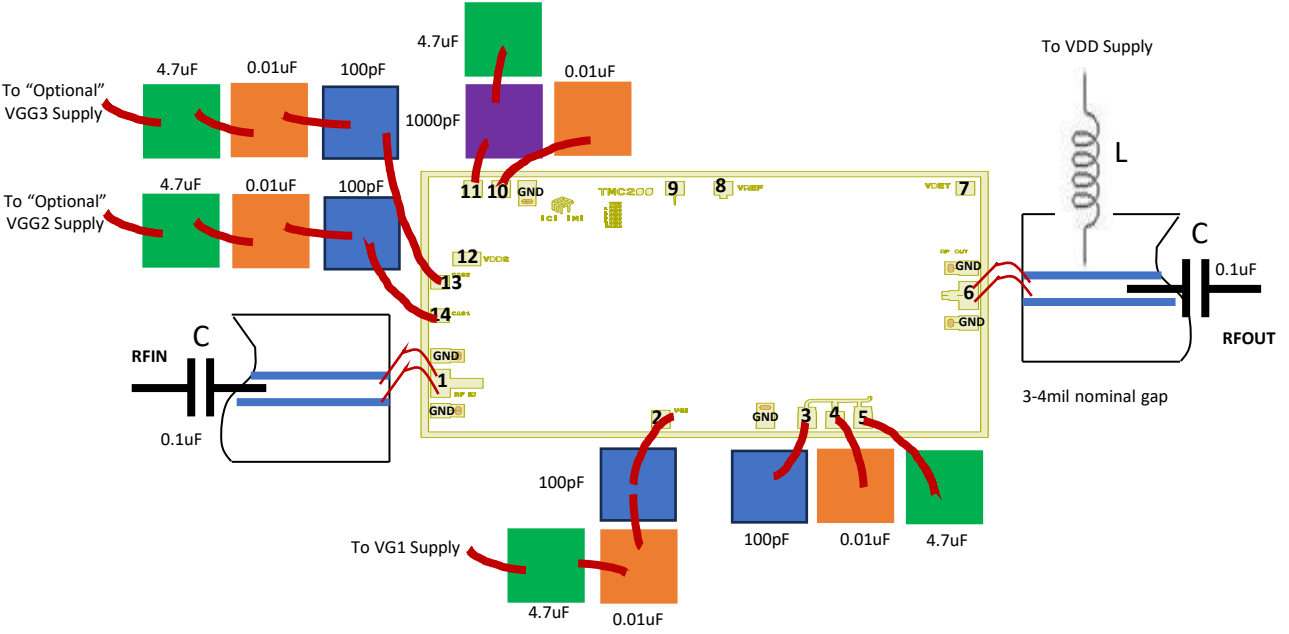

### Application Circuit

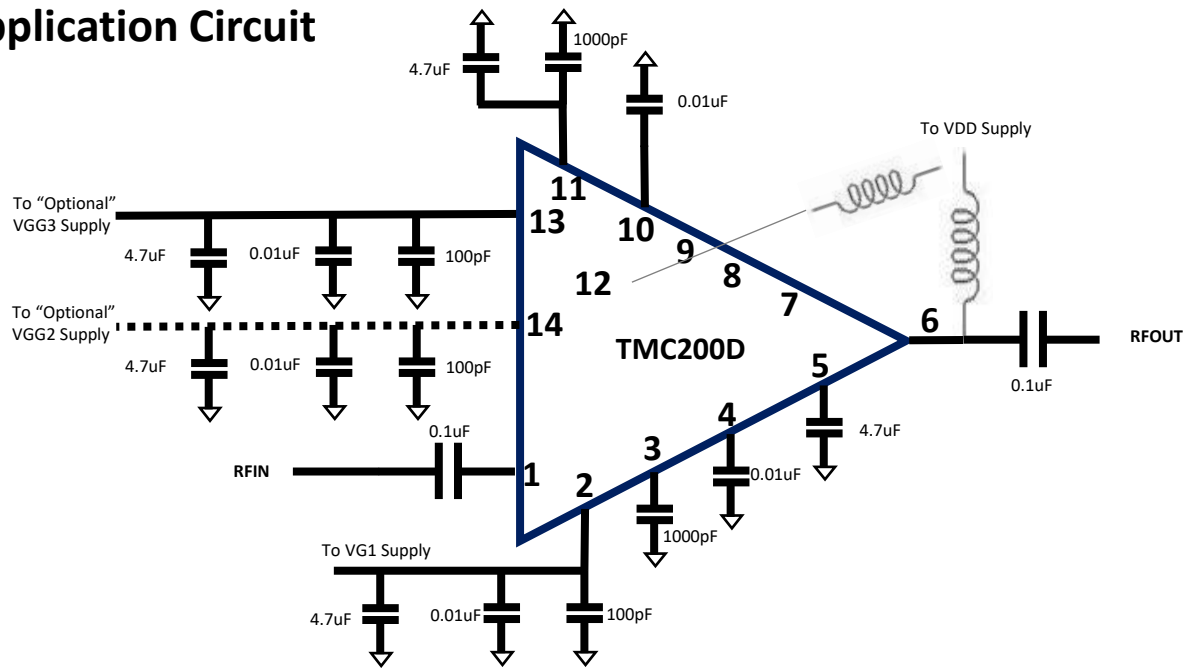

# TMC200D

## DC-28 GHz Distributed Power Amplifier

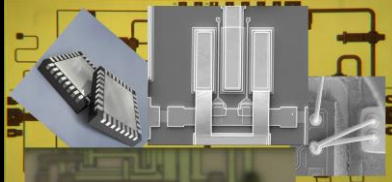

**mmTRON**  
Unleashing the  
mmWave Frontier

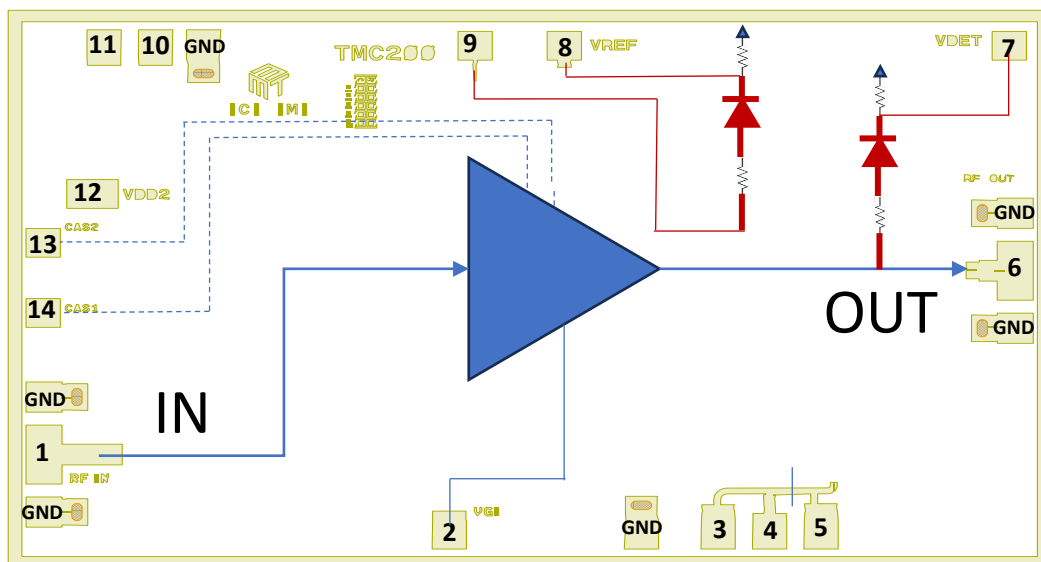

	Absolute Maximum Ratings
Drain Bias Voltage (VDD)	+16V
Gate Bias Voltage (VG1)	-2 to 0V
Gate Bias Current (IG1)	+10mA
RF Input Power (RFIN)(VDD=+12V)	+20 dBm
Channel Temperature	175 °C
Continuous P <sub>diss</sub> (T = 85 °C) (derate 109 mW/°C above 85 °C)	9.2 W
Thermal Resistance (channel to die bottom)	9.8 °C/W
Storage Temperature	-65 to +150 °C
Operating Temperature for MTF > 1E6 hours	-55 to +125 °C

# TMC200D

## DC-28 GHz Distributed Power Amplifier

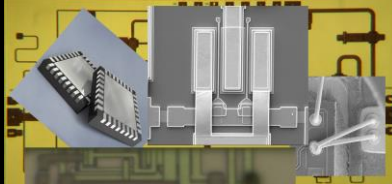

**mmTRON**  
Unleashing the  
mmWave Frontier

### Recommended Biasing

The TMC200D is operated with one positive supply VDD and one negative supply voltage VGG. The positive supply must be connected to the output pad through a bias-T. The negative voltage VGG should be connected to VG1 pad on the die. The VGG is biased to -1V first, then VDD is gradually biased to +10V and finally, VG1 is adjusted to around -0.5V for  $I_{DD}=500\text{mA}$  DC current.

Reverse the sequence during power down, i.e. bring the VGG to -1V, lower VDD to 0V, and then VGG to 0.

### Assembly Techniques

The TMC200D is fabricated using a GaAs-based semiconductor material structure. All bare die are placed Gel based ESD protective containers, and then sealed in an ESD protective bag for shipment. Once the sealed ESD protective bag has been opened, all die should be stored in a humidity-controlled dry nitrogen environment.

Use a vacuum collet sized to handle the chip along the edges to avoid touching the air bridges. The die is back-metalized and can be mounted with standard AuSn eutectic or conductive epoxy assembly techniques. The mounting surface should be clean and flat.

#### Eutectic Die Attach:

The most common eutectic alloy used in die attach is the gold-tin (AuSn) alloy. With a melting point of 280°C, it provides a strong, reliable bond without requiring excessively high temperatures that could potentially damage the die or the substrate. Eutectic die attach is generally performed in a two-step process. First, the eutectic alloy is deposited onto the die or substrate, often by a process such as electroplating or sputtering. This forms what is known as the "preform". Next, the die is placed onto the preform, and the assembly is heated to the melting point of the alloy. This causes the alloy to reflow, spreading out to cover the entire interface between the die and the substrate. Once cooled, the alloy solidifies, creating a robust bond between the die and the substrate. A 80/20 AuSn preform with a work surface temperature of 255 °C is recommended. The tool temperature of 265 ° should be used. The chip should not be exposed to a temperature greater than 300 °C for more than 45 seconds. A maximum 3 seconds of scrubbing should be sufficient for die attachment.

#### Epoxy Die Attach:

Apply a minimum amount of epoxy such as Ablestick 84-1LMI m(0.25-0.75mil) to the mounting surface so that a thin epoxy fillet is observed around the perimeter of the chip once it is placed into position. Cure epoxy per the manufacturer's schedule. The epoxy fillet around the die should be approximately half-way up the side of the 4-mil thick MMIC. Too little epoxy may lead to voids, too much epoxy may lead to stringers and shorts to the front-side metal.

#### Wire Bonding:

RF wedge bonds made with two 1 mil wires are recommended for RF ports. A single 1mil wire can be used for DC pads. Ensure the bonding tool is grounded. These bonds could be bonded thermosonically with a force of 50 grams and a stage temperature of 150 °C. Use a shim under the die to bring the top surface of the die level with the RF input and output transmission line to shorten wirebonds to < 10mil.

### ESD Warning

III-V MMICs are ESD-sensitive. Preventative ESD measures must be employed in all aspects of storage, handling, and assembly. Grounding is critical for floors and all work surfaces, bonding and handling equipment, and other test or assembly machinery. MMIC ESD precautions, handling considerations, and die-attach and bonding methods are critical factors in successful III-V MMIC performance and reliability. Operators should always wear wrist or foot ground straps. ESD test equipment should be available to insure proper ESD grounding at all times.

### RoHS Compliance

This part is RoHS compliant, meeting the requirements of the EU Restriction of Hazardous Substances Directive 2002/95/EC, commonly known as RoHS. Six substances are regulated: lead, mercury, cadmium, chromium VI (hexavalent chromium), polybrominated biphenyls (PBB), and polybrominated biphenyl ethers (PBDE). RoHS compliance requires that any residual concentration of these substances is below the Directive's maximum concentration values (MCV): cadmium 100ppm by weight and all others 1000ppm by weight.



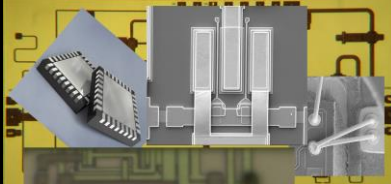

**mmTron Inc. (“mmTron”). All rights reserved.**

The information contained in this this datasheet is for reference only. All specifications are subject to change without prior notice.

Except as provided in its Terms and Conditions of Sale or any separate agreement, mmTron assumes no liability or responsibility whatsoever, including for (i) errors or omissions in these materials; (ii) failure to update these materials; or (iii) conflicts or incompatibilities arising from future changes to specifications and product descriptions, which mmTron may make at any time, without notice. These materials grant no license, express or implied, to any intellectual property rights. THESE MATERIALS ARE PROVIDED "AS IS" WITH NO WARRANTY OR LIABILITY, EXPRESS OR IMPLIED, RELATING TO SALE AND/OR USE OF mmTron PRODUCTS INCLUDING FITNESS FOR A PARTICULAR PURPOSE, MERCHANTABILITY, INFRINGEMENT OF INTELLECTUAL PROPERTY RIGHT, ACCURACY OR COMPLETENESS, OR SPECIAL, INDIRECT, INCIDENTAL, OR CONSEQUENTIAL DAMAGES WHICH MAY RESULT FROM USE OF THESE MATERIALS. mmTron products are not intended for use in medical, lifesaving or life sustaining applications. mmTron customers using or selling mmTron products for use in such applications do so at their own risk and agree to fully indemnify mmTron for any damages resulting from such improper use or sale. These items are controlled by the U.S. Government and authorized for export only to the country of ultimate destination for use by the ultimate consignee or end-user(s) herein identified. They may not be resold, transferred, or otherwise disposed of, to any other country or to any person other than the authorized ultimate consignee or end-user(s), either in their original form or after being incorporated into other items, without first obtaining approval from the U.S. government or as otherwise authorized by U.S. law and regulations’.

The product layout, and specification are mmTron Proprietary and confidential information. The recipient agrees not to copy, alter, modify, reverse engineer, or attempt to derive the composition or underlying information, structure or ideas of any Confidential Information and must not remove, overprint, deface or change any notice of confidentiality, copyright, trademark, logo, legend or other notices of ownership from any originals or copies of mmTron’s information.